



## Module STARK CLE-G2-160-3000 CLASSIC

Modules CLE

### Product description

- Designed for diffuser downlights and wallmounted luminaires
- Ideal to realise simple luminaire designs
- For easy adaptation to existing luminaire architecture
- Self-cooling (no additional heat sink required)
- Efficacy of the module up to 151 lm/W
- High colour rendering index CRI > 80
- Small colour tolerance MacAdam 3<sup>®</sup>
- Colour temperatures 3,000 and 4,000 K
- Long life-time: 50,000 hours, 5-year guarantee



**Standards**, page 3

**For colour temperatures and tolerances**, page 6



Typical application



## Module STARK CLE-G2-160-3000 CLASSIC

Modules CLE

## Technical data

|                            |                |
|----------------------------|----------------|
| Beam characteristic        | 120°           |
| Ambient temperature $t_a$  | -25 ... +45 °C |
| Typ. tp point              | 65 °C          |
| Risk group (EN 62471:2008) | 1              |
| Type of protection         | IP00           |

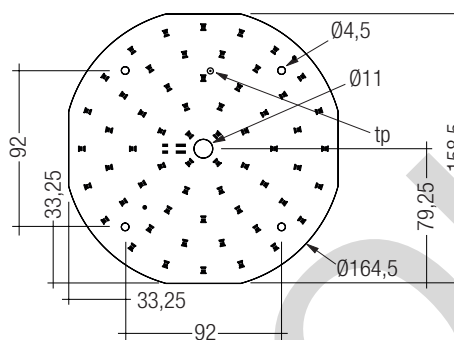

## Ordering data

| Type                          | Article number | Colour temperature | Packaging, carton | Weight per pc. |
|-------------------------------|----------------|--------------------|-------------------|----------------|
| STARK-CLE-G2-160-3000-830-CLA | 89602005       | 3,000 K            | 50 pc(s).         | 0.057 kg       |
| STARK-CLE-G2-160-3000-840-CLA | 89602006       | 4,000 K            | 50 pc(s).         | 0.056 kg       |

## Specific technical data

| Type <sup>®</sup>                  | Photo-metric code | Typ. luminous flux at $t_p = 25\text{ °C}$ <sup>①</sup> | Typ. luminous flux at $t_p = 65\text{ °C}$ <sup>①</sup> | Typ. forward current <sup>②</sup> ③ | Min. forward voltage at $t_p = 65\text{ °C}$ | Max. forward voltage at $t_p = 25\text{ °C}$ | Typ. power consumption at $t_p = 65\text{ °C}$ <sup>④</sup> | Luminous efficacy module at $t_p = 25\text{ °C}$ | Luminous efficacy module at $t_p = 65\text{ °C}$ | Luminous efficacy system at $t_p = 65\text{ °C}$ | Colour index CRI | Energy rendering classifi-cation |
|------------------------------------|-------------------|---|---|-------------------------------------|--|--|---|--|--|--|------------------|----------------------------------|
| <b>Operating mode HE at 350 mA</b> |                   |   |   |                                     |  |  |   |  |  |  |                  |                                  |
| STARK-CLE-G2-160-3000-830-CLA      | 830/349           | 2,180 lm  | 2,070 lm  | 350 mA                              | 41.6 V                                       | 49.0 V                                       | 15.3 W  | 139 lm/W   | 135 lm/W   | 115 lm/W   | > 80             | A+                               |
| STARK-CLE-G2-160-3000-840-CLA      | 840/349           | 2,370 lm  | 2,250 lm  | 350 mA                              | 41.6 V                                       | 49.0 V                                       | 15.3 W  | 151 lm/W   | 147 lm/W   | 125 lm/W   | > 80             | A++                              |
| <b>Operating mode HO at 500 mA</b> |                   |   |   |                                     |  |  |   |  |  |  |                  |                                  |
| STARK-CLE-G2-160-3000-830-CLA      | 830/349           | 2,990 lm  | 2,830 lm  | 500 mA                              | 45.1 V                                       | 53.1 V                                       | 23.1 W  | 126 lm/W   | 123 lm/W   | 107 lm/W   | > 80             | A+                               |
| STARK-CLE-G2-160-3000-840-CLA      | 840/349           | 3,260 lm  | 3,100 lm  | 500 mA                              | 45.1 V                                       | 53.1 V                                       | 23.1 W  | 138 lm/W   | 134 lm/W   | 117 lm/W   | > 80             | A+                               |

<sup>①</sup> Tolerance range for optical and electrical data: ±10 %.

<sup>②</sup> Max. permissible repetitive peak current: 720 mA.

<sup>③</sup> Max. permissible surge current: 0.96 A, duration max. 10 ms.

<sup>④</sup> Integrated measurement over the whole module.

<sup>®</sup> HE ... high efficiency, HO ... high output.

**Standards**

IEC 62031  
IEC 62471  
IEC 61000-4-2  
IEC 62717

**Photometric code**

Key for photometric code, e. g. 830 / 449

| 1 <sup>st</sup> digit | 2 <sup>nd</sup> + 3 <sup>rd</sup> digit | 4 <sup>th</sup> digit | 5 <sup>th</sup> digit                           | 6 <sup>th</sup> digit                                    |
|-----------------------|---|-----------------------|---|--|
| Code CRI              | Colour temperature in Kelvin x 100      | McAdam initial        | McAdam after 25% of the life-time (max. 6,000h) | Lumen maintenance after 25% of the life-time (max.6000h) |
| 7 67 – 76             |   |                       |   | Code Remaining lumen                                     |
| 8 77 – 86             |   |                       |   | 7 ≥ 70 %   |
| 9 87 – ≥90            |   |                       |   | 8 ≥ 80 %   |
|                       |   |                       |   | 9 ≥ 90 %   |

**Thermal design and heat sink**

The rated life of LED products depends to a large extent on the temperature. If the permissible temperature limits are exceeded, the life of the CLE will be greatly reduced or the CLE may be destroyed.

**tp point, ambient temperature and life-time**

The temperature at tp reference point is crucial for the light output and life-time of a LED product.

For CLE a tp temperature of 65 °C has to be complied in order to achieve an optimum between light output and life-time.

Compliance with the maximum permissible reference temperature at the tp point must be checked under operating conditions in a thermally stable state. The maximum value must be determined under worst-case conditions for the relevant application.

The tc and tp temperature of LED modules from Tridonic are measured at the same reference point.

**Mounting instruction**

None of the components of the CLE (substrate, LED, electronic components etc.) may be exposed to tensile or compressive stresses.

Max. torque for fixing: 0,5 Nm.

The LED modules are mounted with 4 screws per module. In order not to damage the modules only rounded head screws and an additional plastic flat washer should be used.



Chemical substance may harm the LED module. Chemical reactions could lead to colour shift, reduced luminous flux or a total failure of the module caused by corrosion of electrical connections.

Materials which are used in LED applications (e.g. sealings, adhesives) must not produce dissolver gas. They must not be condensation curing based, acetate curing based or contain sulfur, chlorine or phthalate.

Avoid corrosive atmosphere during usage and storage.

**EOS/ESD safety guidelines**

The device / module contains components that are sensitive to electrostatic discharge and may only be installed in the factory and on site if appropriate EOS/ESD protection measures have been taken. No special measures need be taken for devices/modules with enclosed casings (contact with the pc board not possible), just normal installation practice. Please note the requirements set out in the document EOS / ESD guidelines (Guideline\_EOS\_ESD.pdf) at: <http://www.tridonic.com/esd-protection>

**Thermal behaviour**

|                           |               |
|---------------------------|---------------|
| storage temperature       | -30... +80 °C |
| operating temperature ta  | -25... +45 °C |
| tp (at typ. current)      | 65 °C         |
| tc max. (at typ. current) | 75 °C         |
| max. humidity*            | 0...70%       |

\* not condensed

**Life-time, lumen maintenance and failure rate**

The light output of an LED Module decreases over the life-time, this is characterized with the L value.

L70 means that the LED module will give 70 % of its initial luminous flux.

This value is always related to the number of operation hours and therefore defines the life-time of an LED module.

As the L value is a statistical value and the lumen maintenance may vary over the delivered LED modules.

The B value defines the amount of modules which are below the specific L value, e.g. L70B10 means 10 % of the LED modules are below 70 % of the initial luminous flux, respectively 90 % will be above 70 % of the initial value. In addition the percentage of failed modules (fatal failure) is characterized by the C value.

The F value is the combination of the B and C value. That means for F degradation and complete failures are considered, e.g. L70F10 means 10 % of the LED modules may fail or be below 70 % of the initial luminous flux.

**Lumen maintenance for CLE 160**

| Forward current | tp temperature | L90 / F10 | L90 / F50 | L80 / F10 | L80 / F50 | L70 / F10 | L70 / F50 |
|-----------------|----------------|-----------|-----------|-----------|-----------|-----------|-----------|
| 500 mA          | 65 °C          | 14,000 h  | 35,000 h  | 37,000 h  | 50,000 h  | 43,000 h  | 50,000 h  |

Life-time declarations are informative and represent no warranty claim.

**Selection of the LED Driver**

CLE module can be operated either from SELV LED Drivers or from LED Drivers with LV output voltage.



CLE modules are basic isolated up to 150 V against ground and can be mounted directly on earthed metal parts of the luminaire. If the max. output voltage of the LED Driver (also against earth) is above 150 V, an additional isolation between LED module and heat sink is required (for example by isolated thermal pads) or by a suitable luminaire construction.

At voltages > 60 V an additional protection against direct touch (test finger) to the light emitting side of the module has to be guaranteed. This is typically achieved by means of a non removable light distributor over the module.

**Electrical supply/choice of LED Driver**

CLE modules from Tridonic are not protected against overvoltages, overcurrents, overloads or short-circuit currents. Safe and reliable operation can only be guaranteed in conjunction with a LED Driver which complies with the relevant standards. The use of LED Driver from Tridonic in combination with CLE modules guarantees the necessary protection for safe and reliable operation.

If a LED Driver other than Tridonic is used, it must provide the following protection:

- Short-circuit protection
- Overload protection
- Overtemperature protection



CLE modules must be supplied by a constant current LED Driver. Operation with a constant voltage LED Driver will lead to an irreversible damage of the module.

Wrong polarity can damage the CLE.

With parallel wiring tolerance-related differences in output are possible (thermal stress of the module) and can cause differences in brightness. If one module fails, the remaining modules may be overloaded.

Wiring

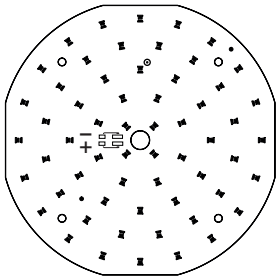

Wiring type and cross section

The wiring can be solid cable with a cross section of 0.4 to 0.75 mm<sup>2</sup>. For the push-wire connection you have to strip the insulation (7–9 mm). Loosen wire through twisting and pulling.

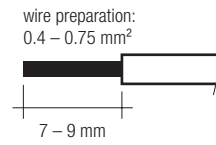

Release of the wiring

Press down the “push button” and remove the cable from front.

Wiring example

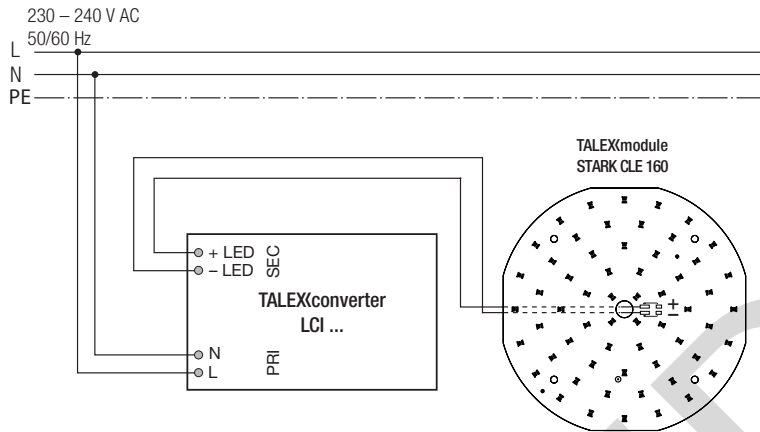

Forward current vs. forward voltage

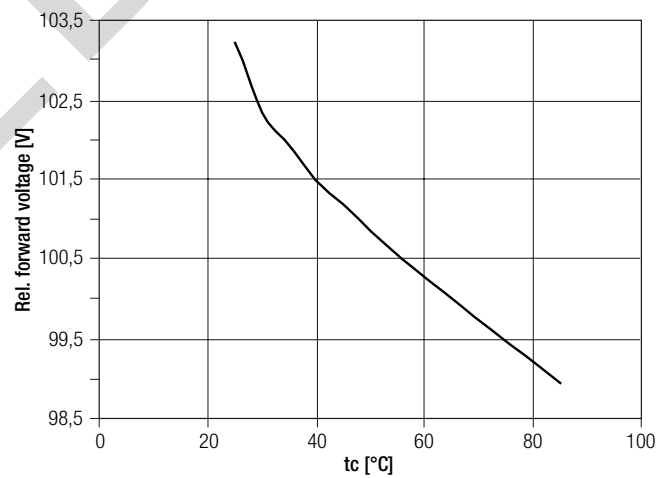
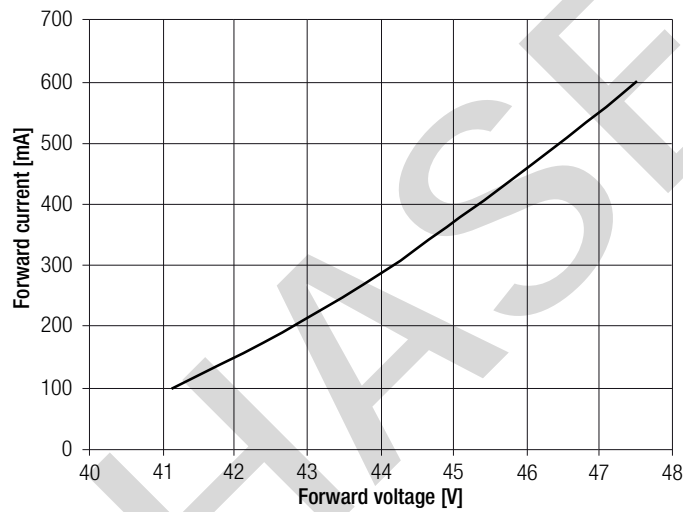

Relative luminous flux

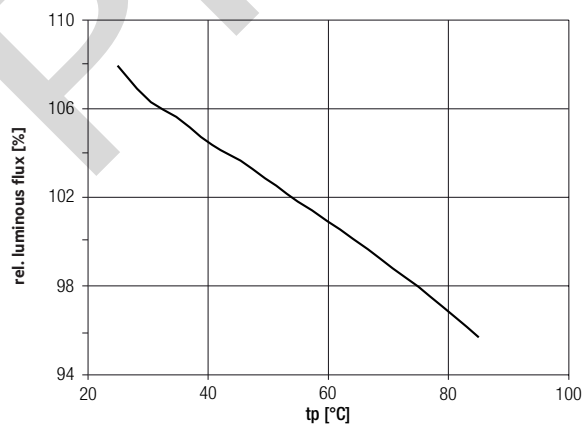

Relative luminous flux vs. operating current

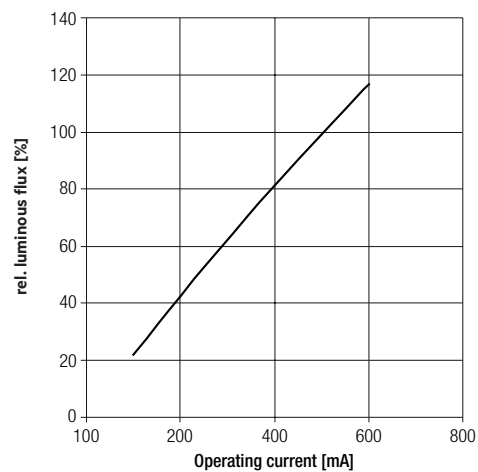

The diagrams based on statistic values. The real values can be different.

### Optical characteristics CLE

The optical design of the CLE product line ensures optimum homogeneity for the light distribution.

### Light distribution

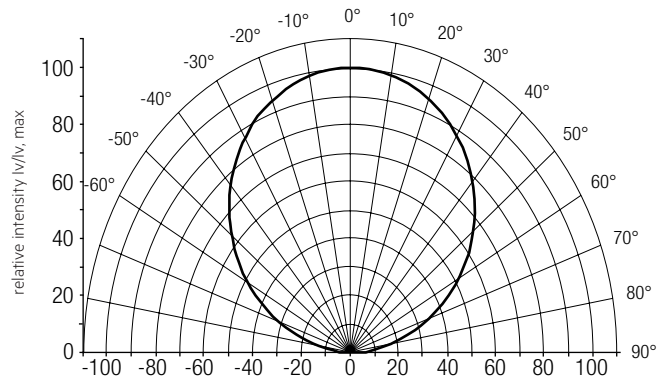

The colour temperature is measured over the complete module. The single LED light points can be outside of 3SDCM. To ensure an ideal mixture of colours and a homogenous light distribution a suitable optic (e. g. PMMA diffuser) and a sufficient spacing between module and optic (typ. 5 cm) should be used.

3D-Data, photometric data and Design-in guide available on request or go to [www.tridonic.com](http://www.tridonic.com)

## Coordinates and tolerances according to CIE 1931

The specified colour coordinates are measured integral by a current impulse with typical values of module and a duration of 100 ms.

The ambient temperature of the measurement is  $t_a = 25\text{ }^\circ\text{C}$ .

The measurement tolerance of the colour coordinates are  $\pm 0.01$ .

## 3,000 K

|        | x0     | y0     |
|--------|--------|--------|
| Centre | 0.4344 | 0.4032 |

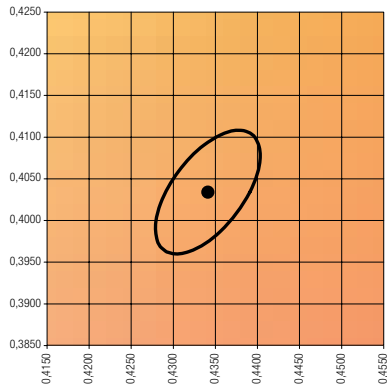

— MacAdam Ellipse: 3SDCM

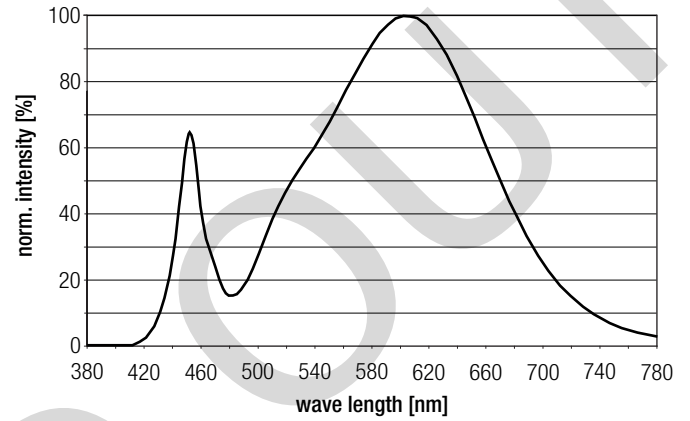

## 4,000 K

|        | x0     | y0     |
|--------|--------|--------|
| Centre | 0.3825 | 0.3796 |

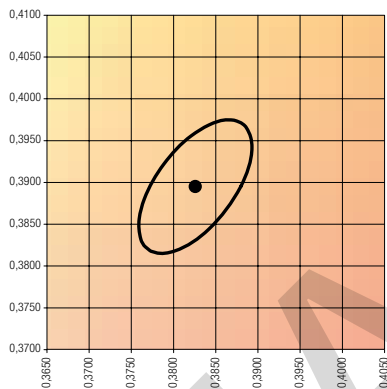

— MacAdam Ellipse: 3SDCM

