



Engine STARK CLE-AC-160-1500

Engine CLE advanced

Product description

- Module with integrated electronic
- Economic one-piece solution
- Easy Refitting of existing luminaires
- Ideal for ceiling-mounted and wallmounted luminaires
- Enables thin designs of luminaires
- High colour rendering index CRI > 80
- Small colour tolerance MacAdam 3
- System efficacy of the module up to 100 lm/W
- Integrated separate emergency LED modules with type EM, controlled via EM powerLED
- Simple CORRIDOR FUNCTION in combination with any sensor
- Touch cover: Protection against direct touch of active parts in transparent or diffuse finish, see accessories
- Life-time 50,000 h L80F10
- 5-year guarantee

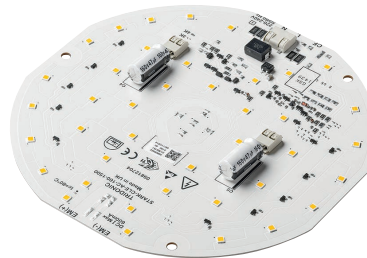

CLE-AC-160

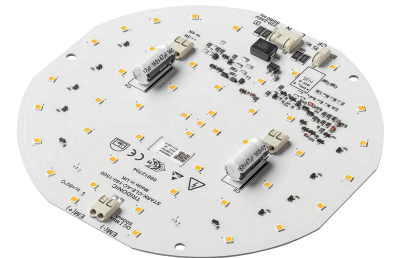

CLE-AC-160 EM

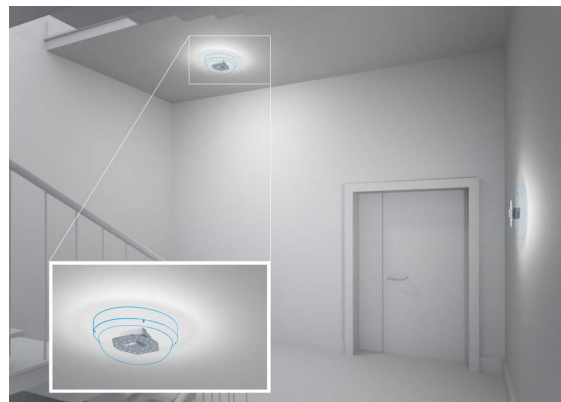

ACC COVER 160mm TRANSP



Engine STARK CLE-AC-160-1500

Modules CLE advanced

Technical data

| | |
|--------------------------------------------|----------------|
| Rated supply voltage | 220 – 240 V |
| Input voltage, AC | 198 – 264 V |
| Mains frequency | 50 / 60 Hz |
| Typ. λ | 0.97 |
| THD | 20 % |
| Starting time (at 230 V, 50 Hz, full load) | \leq 0.5 s |
| Beam characteristic | 120° |
| Ambient temperature t_a | -25 ... +55 °C |
| Typ. tp point | 65 °C |
| Risk group (EN 62471:2008) | 1 |
| Type of protection | IP00 |

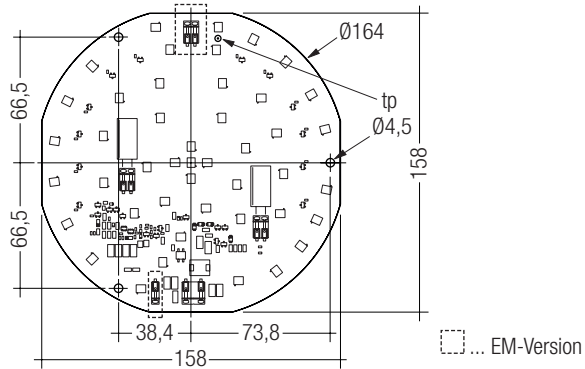

Ordering data

| Type | Article number | Colour temperature | Packaging carton | Weight per pc. |
|-------------------------------------|----------------|--------------------|------------------|----------------|
| STARK CLE-AC-160-1500-830-CLA | 89800421 | 3.000 K | 10 pc(s). | 0.065 kg |
| STARK CLE-AC-160-1500-840-CLA | 89800422 | 4.000 K | 10 pc(s). | 0.065 kg |
| STARK CLE-AC-160-1500-830-CLA EM-CF | 89800423 | 3.000 K | 10 pc(s). | 0.065 kg |
| STARK CLE-AC-160-1500-840-CLA EM-CF | 89800424 | 4.000 K | 10 pc(s). | 0.065 kg |

Specific technical data

| Type | Photometric code | Typ. luminous flux at $t_p = 25\text{ °C}^{\text{①}}$ | Typ. luminous flux at $t_p = 65\text{ °C}^{\text{①}}$ | Input current ^① | Input power ^① | Efficacy of the system at $t_p = 65\text{ °C}$ | Colour rendering index CRI | Energy classification |
|-------------------------------------|------------------|-------------------------------------------------------|-------------------------------------------------------|----------------------------|--------------------------|------------------------------------------------|----------------------------|-----------------------|
| Normal operation | | | | | | | | |
| STARK CLE-AC-160-1500-830-CLA | 830/339 | 1,600 lm | 1,450 lm | 65 mA | 14.5 W | 100 lm/W | > 80 | A+ |
| STARK CLE-AC-160-1500-840-CLA | 840/339 | 1,600 lm | 1,450 lm | 65 mA | 14.5 W | 100 lm/W | > 80 | A+ |
| Emergency operation | | | | | | | | |
| STARK CLE-AC-160-1500-830-CLA EM-CF | 830/339 | 130 lm | 120 lm | – | – | – | > 80 | – |
| STARK CLE-AC-160-1500-840-CLA EM-CF | 840/339 | 130 lm | 120 lm | – | – | – | > 80 | – |

^① Tolerance range for optical and electrical data: $\pm 10\%$.

Product description

- Cover for CLE-AC-160
- Protection against direct touch of active parts
- Fixation with non-removable fasteners
- High transmission: 92 % for transparent version, 68 % for diffuse version
- Touch cover made of Polycarbonat



ACC COVER 160mm TRANSP



ACC COVER 160mm DIFFUSE

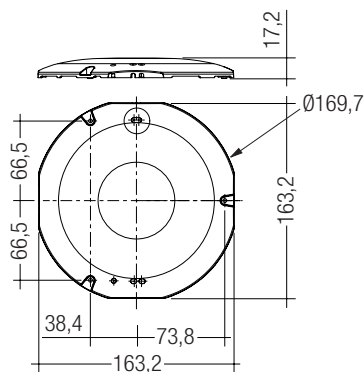

Ordering data

| Type | Article number | Colour | Packaging carton | Weight per pc. |
|-------------------------|----------------|-------------|------------------|----------------|
| ACC COVER 160mm TRANSP | 28001033 | Transparent | 10 pc(s). | 0.048 kg |
| ACC COVER 160mm DIFFUSE | 28001759 | Diffuse | 10 pc(s). | 0.048 kg |

1. Standards

- EN 55015
- EN 61000-3-2
- EN 61547
- EN 62031
- EN 62471

1.1 Photometric code

Key for photometric code, e. g. 830 / 559

| 1 st digit | 2 nd + 3 rd digit | 4 th digit | 5 th digit | 6 th digit |
|-----------------------|-----------------------------------------|-----------------------|------------------------------------------------|----------------------------------------------------------|
| Code CRI | Colour temperature in Kelvin x 100 | MacAdam initial | MacAdam after 25% of the life-time (max.6000h) | Lumen maintenance after 25% of the life-time (max.6000h) |
| 7 | 67 – 76 | | | Code Remaining lumen |
| 8 | 77 – 86 | | | 7 ≥ 70 % |
| 9 | 87 – ≥90 | | | 8 ≥ 80 % |
| | | | | 9 ≥ 90 % |

2. Thermal details

2.1 tc point, ambient temperature and life-time

The temperature at tp reference point is crucial for the light output and life-time of a LED product.

For STARK CLE a tp temperature of 65 °C has to be complied in order to achieve an optimum between heat sink requirements, light output and life-time.

Compliance with the maximum permissible reference temperature at the tp point must be checked under operating conditions in a thermally stable state. The maximum value must be determined under worst-case conditions for the relevant application.

The tc and tp temperature of LED modules from Tridonic are measured at the same reference point.

2.2 Thermal behaviour

| | |
|---------------------------|--------------|
| storage temperature | -40...+85 °C |
| operating temperature ta | -25...+55 °C |
| tp (at typ. current) | 65 °C |
| tc max. (at typ. current) | 80 °C |
| max. humidity | 0...80 % |

* not condensating

2.3 Thermal design and heat sink

The rated life of LED products depends to a large extent on the temperature. If the permissible temperature limits are exceeded, the life of the STARK CLE will be greatly reduced or the STARK CLE may be destroyed.

2.4 Heat sink values

STARK CLE-AC-160-1500

| ta | tp | R _{th, hs-a} | Cooling area |
|-------|-------|-----------------------|-----------------------|
| 25 °C | 65 °C | 3.80 K/W | 261 cm ² |
| 35 °C | 65 °C | 2.80 K/W | 352 cm ² |
| 45 °C | 65 °C | 1.80 K/W | 539 cm ² |
| 55 °C | 65 °C | 0.85 K/W | 1,156 cm ² |

Notes

The actual cooling surface can differ because of the material, the structural shape, outside influences and the installation situation. Depending on the heat sink a heat conducting paste or heat conducting film might be necessary to keep the specified tp temperature.

3. Installation / wiring

3.1 Wiring

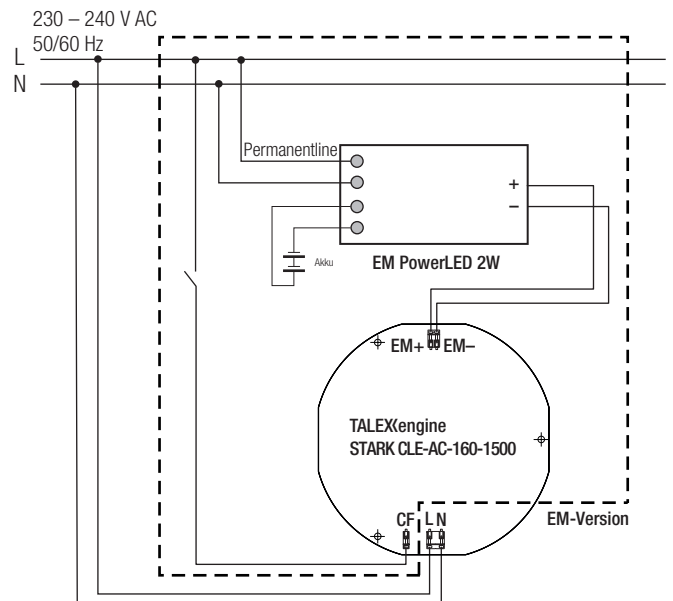

3.2 Wiring type and cross section

The wiring can be solid or flexible wire with a cross section of 0.5 to 0.75 mm². For the push-wire connection you have to strip the insulation (6-7 mm).

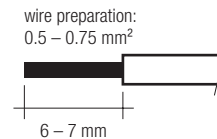

Inserting stranded wires / removing wires by lightly pressing on the push button.

3.3 Mounting instruction



None of the components of the STARK CLE (substrate, LED, electronic components etc.) may be exposed to tensile or compressive stresses.

Max. torque for fixing: 0.5 Nm.

The LED modules are mounted onto a heat sink with 3 screws per module. In order not to damage the modules only rounded head screws and an additional plastic flat washer should be used.



Chemical substance may harm the LED module. Chemical reactions could lead to colour shift, reduced luminous flux or a total failure of the module caused by corrosion of electrical connections.

Materials which are used in LED applications (e.g. sealings, adhesives) must not produce dissolver gas. They must not be condensation curing based, acetate curing based or contain sulfur, chlorine or phthalate.

Avoid corrosive atmosphere during usage and storage.

3.4 Safety instructions



A protection against direct touch (test finger) to the module has to be guaranteed. This is typically achieved by means of a non removable light distributor over the module.
E.g. ACC COVER 160mm in combination with non removable plastic clips.

4. Life-time

4.1 Life-time, lumen maintenance and failure rate

The light output of an LED Module decreases over the life-time, this is characterized with the L value.

L70 means that the LED module will give 70 % of its initial luminous flux.

This value is always related to the number of operation hours and therefore defines the life-time of an LED module.

As the L value is a statistical value and the lumen maintenance may vary over the delivered LED modules.

The B value defines the amount of modules which are below the specific L value, e.g. L70B10 means 10 % of the LED modules are below 70 % of the initial luminous flux, respectively 90 % will be above 70 % of the initial value. In addition the percentage of failed modules (fatal failure) is characterized by the C value.

The F value is the combination of the B and C value. That means for F degradation and complete failures are considered, e.g. L70F10 means 10 % of the LED modules may fail or be below 70 % of the initial luminous flux.

5. Electrical values

5.1 Maximum loading of automatic circuit breakers

| Automatic circuit breaker type | C10 | C13 | C16 | C20 | B10 | B13 | B16 | B20 | Inrush current | |
|--------------------------------|---------------------|---------------------|---------------------|---------------------|---------------------|---------------------|---------------------|---------------------|----------------|---------|
| Installation Ø | 1.5 mm ² | 1.5 mm ² | 1.5 mm ² | 2.5 mm ² | 1.5 mm ² | 1.5 mm ² | 1.5 mm ² | 2.5 mm ² | I_{max} | time |
| STARK CLE-AC-160-1500 | 90 | 130 | 130 | 130 | 90 | 130 | 130 | 130 | 4.8 A | 0.55 µs |

5.2 Insulation and electric strength testing of luminaires

Electronic devices can be damaged by high voltage. This has to be considered during the routine testing of the luminaires in production.

According to IEC 60598-1 Annex Q (informative only!) or ENEC 303-Annex A, each luminaire should be submitted to an insulation test with 500 V_{DC} for 1 second. This test voltage should be connected between the interconnected phase and neutral terminals and the earth terminal.

The insulation resistance must be at least 2 MΩ.

As an alternative, IEC 60598-1 Annex Q describes a test of the electrical strength with 1500 V_{AC} (or 1.414 x 1500 V_{DC}). To avoid damage to the electronic devices this test must not be conducted.

5.3 AC operation

Mains voltage:

220–240 V 50/60 Hz

198–264 V 50/60 Hz for safety

207–254 V 50/60 Hz for performance

3.5 EOS/ESD safety guidelines



The device / module contains components that are sensitive to electrostatic discharge and may only be installed in the factory and on site if appropriate EOS/ESD protection measures have been taken. No special measures need be taken for devices/modules with enclosed casings (contact with the pc board not possible), just normal installation practice. Please note the requirements set out in the document EOS / ESD guidelines (Guideline_EOS_ESD.pdf) at: <http://www.tridonic.com/esd-protection>

4.2 Lumen maintenance for STARK CLE-AC-160-1500

| t_p temperature | L90 / F10 | L90 / F50 | L80 / F10 | L80 / F50 | L70 / F10 | L70 / F50 |
|----------------------|-----------|-----------|-----------|-----------|-----------|-----------|
| 65 °C | 25,000 h | 50,000 h | 50,000 h | 50,000 h | 50,000 h | 50,000 h |

The L70 / F50 lumen maintenance value represents the expected life-time of the module with a failure probability of less than 10 %.

6. Photometric characteristics

6.1 Coordinates and tolerances according to CIE 1931

The specified colour coordinates are integral measured by a current impulse with typical values of module and a duration of 200 ms.
The ambient temperature of the measurement is $t_a = 25^\circ\text{C}$.
The measurement tolerance of the colour coordinates are ± 0.01 .

6.2 Colour coordinates for LED module without housing

3,000 K

| | x0 | y0 |
|--------|--------|--------|
| Centre | 0,4344 | 0,4032 |

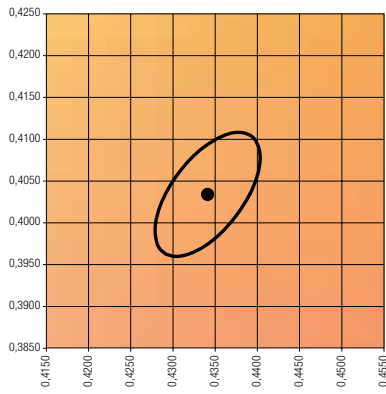

— MacAdam Ellipse: 3SDCM

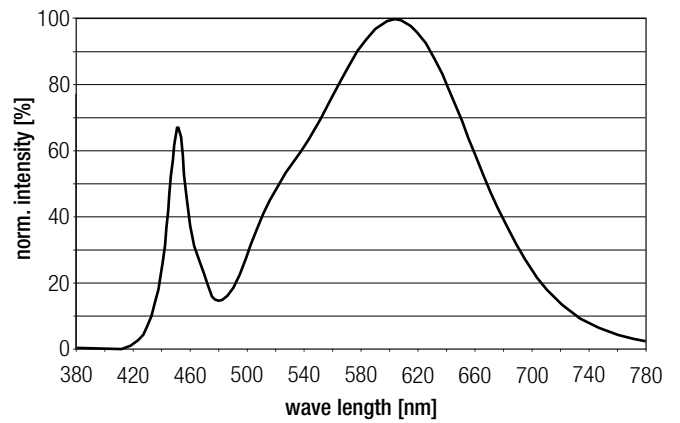

4,000 K

| | x0 | y0 |
|-------------|--------|--------|
| Mittelpunkt | 0,3828 | 0,3803 |

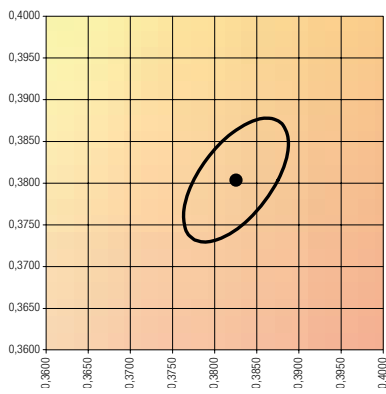

— MacAdam Ellipse: 3SDCM

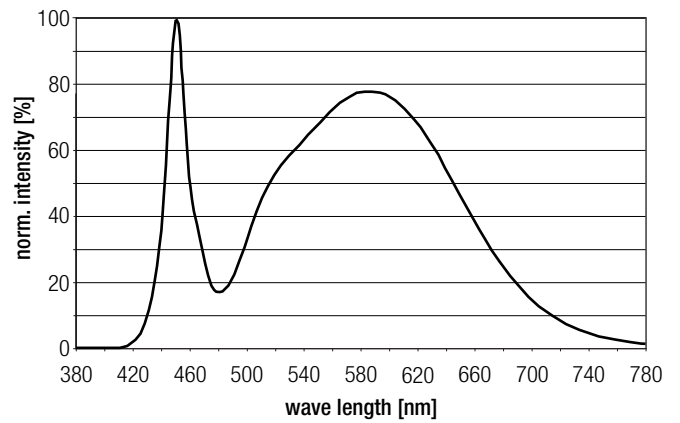

6.3 Light distribution

The optical design of the STARK LLE product line ensures optimum homogeneity for the light distribution.

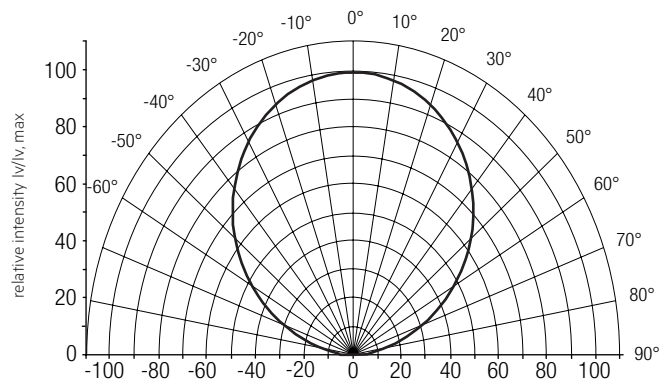

The colour temperature is measured integral over the complete module. The single LED light points can have deviations in the colour coordinates within MacAdam 7.

To ensure an ideal mixture of colours and a homogenous light distribution a suitable optic (e. g. PMMA diffuser) and a sufficient spacing between module and optic (typ. 4 cm) should be used.

7. Miscellaneous

7.1 Additional information

Additional technical information at www.tridonic.com → Technical Data

Guarantee conditions at www.tridonic.com → Services

Life-time declarations are informative and represent no warranty claim.