

Driver LCAI 38/75W TW Ip

Tunable White

Product description

- 2-channel LED Driver with DALI DT8
- Output power: 38 W or 75 W
- Power input on standby < 0.3 W
- Nominal life-time up to 50,000 h
- 5-year guarantee

Properties

- Low-profile LED Driver with digital interface (DALI Device Type 8, DSI, switchDIM, colourTEMPERATURE)
- switchDIM and colourTEMPERATURE with memory function[®]
- Powerless switching via digital interface (no need for switching via mains)
- Intelligent Temperature Guard (protection against thermal damage)
- Short-circuit shutdown feature with one restart (after 0.5 s)
- Overload protection with one restart (after 0.5 s)



Standards, page 3



IP20         RoHS

Driver LCAI 38/75W TW Ip

Tunable White

Technical data

Rated supply voltage	220 – 240 V
AC voltage range	198 – 264 V
DC voltage range	176 – 280 V
Rated current (at 230 V 50 Hz) for 38 W	0.18 A
Rated current (at 230 V 50 Hz) for 75 W	0.35 A
Mains frequency	0 / 50 / 60 Hz
Efficiency for 38 W	90 %
Efficiency for 75 W	93 %
λ (at 230 V 50 Hz, full load)	0.96
Control input ^①	DSI, DALI, switchDIM, colourTEMPERATURE
Stand-by power ^②	< 0.3 W
Min. forward voltage	125 V
Max. forward voltage	250 V
Dimming range	10 – 100 %
PWM frequency	200 – 500 Hz
Set up time (at 230 V, 50 Hz)	< 0.5 s
Switchover time (AC/DC) ^③	< 1 s
Leakage current (PE)	150 μ A
Output current tolerance ^④	\pm 2 %
Max. output current peak (non-repetitive) for 38 W	180 mA
Max. output current peak (non-repetitive) for 75 W	360 mA
Max. output voltage (no-load voltage)	270 V
Suitable for burst / surge peaks up to (between L – N)	1.2 kV
Suitable for burst / surge peaks up to (between L/N – PE)	2 kV
Burst / surge peaks output side against PE	< 2 kV
t_a operating (at life-time 50,000 h) for 38 W	-25 ... +60 °C
t_a operating (at life-time 50,000 h) for 75 W	-25 ... +55 °C
Max. casing temperature t_c (at life-time 50,000 h) for 38 W	70 °C
Max. casing temperature t_c (at life-time 50,000 h) for 75 W	75 °C

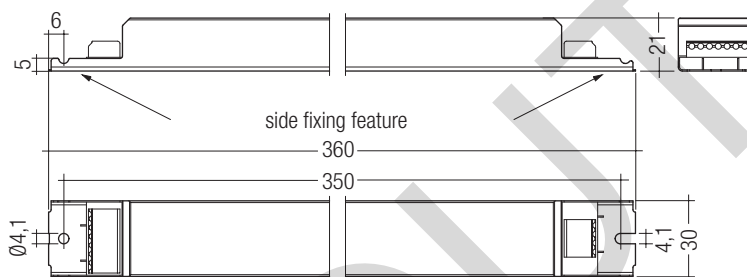

Ordering data

Type	Article number	Packaging carton	Packaging pallet	Weight per pc.
LCAI 38W 125mA DT8 Ip	28001457	80 pc(s).	320 pc(s).	0.265 kg
LCAI 75W 250mA DT8 Ip	28001458	80 pc(s).	320 pc(s).	0.265 kg

Specific technical data

Type	Output current ^⑤	Min. forward voltage	Max. forward voltage	Min. output power	Max. output power
LCAI 38W 125mA DT8 Ip	100 mA	125 V	250 V	12.5 W	25.0 W
	150 mA	125 V	250 V	18.8 W	37.5 W
LCAI 75W 250mA DT8 Ip	200 mA	125 V	250 V	25.0 W	50.0 W
	300 mA	125 V	250 V	37.5 W	75.0 W

^① In DC operation the last set colour is used. No colourTEMPERATURE mode at DC operation.

^② Valid at 100 % dimming level.

^③ Depending on the DALI traffic at the interface.

^④ Output current is mean value.

^⑤ Valid for immediate change of power supply type otherwise the starting time is valid.

Standards

EN 61347-1
 EN 61347-2-13
 EN 62384
 EN 61000-3-2
 EN 61547
 EN 55015
 EN 62493
 EN 62386-101
 EN 62386-102
 EN 62386-209 (DALI DEVICE Type 8)

Control input (DA/D1, DA/D2)

Digital DALI/DSI signal or switchDIM can be wired on the same terminals (DA/D1 and DA/D2).

Digital signal DALI/DSI

The control input is non-polar and protected against accidental connection with a mains voltage up to 264 V. The control signal is not SELV. Control cable has to be installed in accordance to the requirements of low voltage installations. Different functions depending on each module.

Colour types

Supported colour types according to DALI Device Type 8:

- colour temperature (colourTEMPERATURE)

Thermal protection of the unit

The unit also has an ITG (Intelligent Temperature Guard). This protects the LCAI TW Ip from thermal overload by reducing the output power or switching off in case of operation above the thermal limits of the luminaire or ballast. Depending on the luminaire design, the ITG operates at about 12 °C (± 5 °C) above t_c temperature.

Control via switchDIM and colourTEMPERATURE

A conventional double pushbutton can be used to control the system via switchDIM and colourTEMPERATURE. One of the pushbuttons is used to set the colour temperature, the other to set the dimming level.



Pushbuttons with glow lamps affect the switchDIM and colourTEMPERATURE and should therefore not be used for this purpose.

For control via a double pushbutton different settings can be made:

- Setting the colour temperature via colourTEMPERATURE mode with 7 values between minimum and maximum colour temperature.
- Stepless setting of the dimming level between 10 and 100 %.
- These values can be changed via masterCONFIGURATOR.

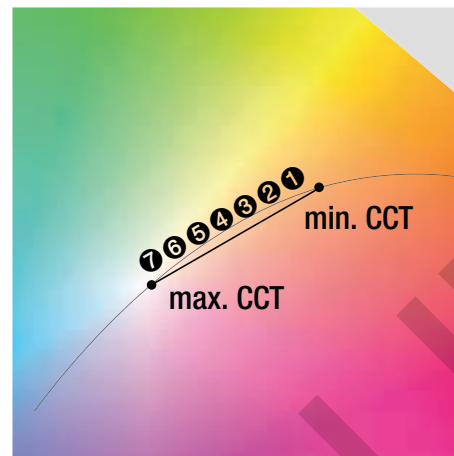
colourTEMPERATURE mode

Setting the colour temperature

The procedure for setting the colour temperature mode (colourTEMPERATURE):

- Press the pushbutton briefly (approx. 1 s) to advance the colour temperature by one step



When reaching the maximum value the LED module will flash shortly. Another press on the pushbutton will switch the colour temperature immediately to the minimum value.

- Alternatively the colour temperature could be changed via DALI device type 8 control system.

Light level in DC operation

The LED Driver is designed for operation on DC voltage and pulsed DC voltage.

Light output level in DC operation: programmable 10 – 100 % (EOFx = 0.13). Programming by DALI.

In DC operation dimming mode can be activated.

The voltage-dependent input current of Driver incl. LED module is depending on the used load.

Dimming

Dimming range 10% to 100%

Digital control with:

- DSI signal: 8 bit Manchester Code
Speed 10% to 100% in 1.4 s
 - DALI signal: 16 bit Manchester Code
Speed 10% to 100% in 0.1s
- Programmable parameter:
Minimum dimming level
Maximum dimming level
Default minimum = 10 %
Programmable range 10 % ≤ MIN ≤ 100 %
Default maximum = 100 %
Programmable range 100 % ≥ MAX ≥ 10 %

Dimming curve is adapted to the eye sensitiveness.

Dimming characteristics

Digital dimming value

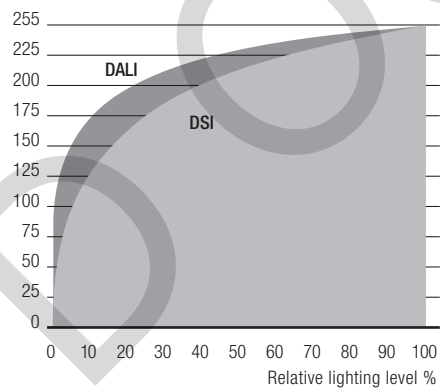

Dimming characteristics as seen by the human eye

4.2 Efficiency vs dimming level

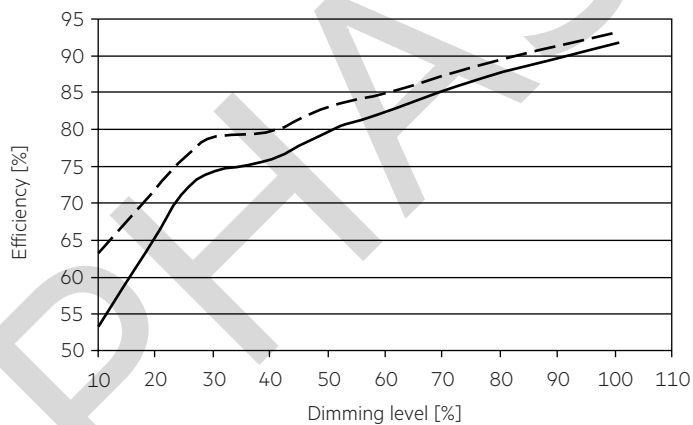

— LCAI 38W
- - - LCAI 75W

4.3 Power factor vs dimming level

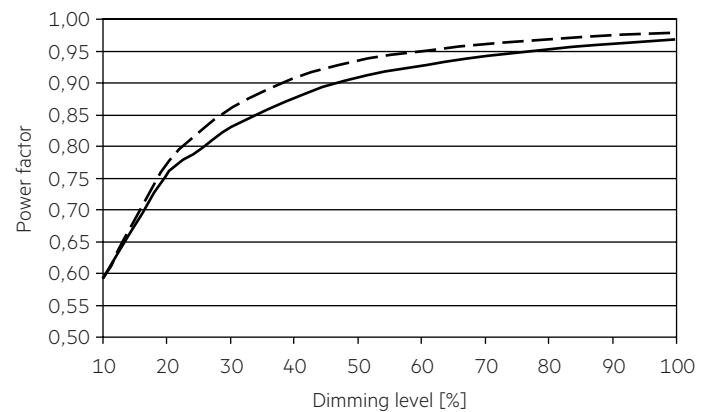

Expected life-time

Expected life-time

Type	ta	40 °C	50 °C	55 °C	60 °C
LCAI 38W 125mA DT8 Ip	tc	55 °C	60 °C	65 °C	70 °C
	Life-time	> 100.000 h	> 100.000 h	> 100.000 h	80.000 h
LCAI 75W 250mA DT8 Ip	tc	61 °C	70 °C	75 °C	80 °C
	Life-time	> 100.000 h	90.000 h	60.000 h	45.000 h

The LED Driver is designed for a life-time stated above under reference conditions and with a failure probability of less than 10 %.

The relation of tc to ta temperature depends also on the luminaire design.

If the measured tc temperature is approx. 5 K below tc max., ta temperature should be checked and eventually critical components (e.g. ELCAP) measured. Detailed information on request.

Maximum loading of automatic circuit breakers

Automatic circuit breaker type	C10	C13	C16	C20	B10	B13	B16	B20	Inrush current	
Installation Ø	1.5 mm ²	1.5 mm ²	1.5 mm ²	2.5 mm ²	1.5 mm ²	1.5 mm ²	1.5 mm ²	2.5 mm ²	I _{max}	time
LCAI 38 W 125 mA TW Ip	22	30	40	58	11	15	20	29	23 A	290 µs
LCAI 75 W 250 mA TW Ip	14	20	28	38	7	10	14	19	26 A	350 µs

Harmonic distortion in the mains supply (at 230 V / 50 Hz and full load) in %

Type	THD	3	5	7	9	11
LCAI 38 W 125 mA TW Ip	< 12	9	5	4	1	2
LCAI 75 W 250 mA TW Ip	< 9	6	5	4	3	2

Wiring type and cross section

Solid wire with a cross section of 0.5 – 1.5 mm². Strip 8 – 9 mm of insulation from the cables to ensure perfect operation of terminals.

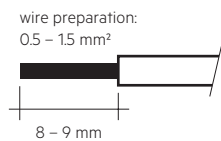

Wiring instructions

The secondary leads should be separated from the mains connections and wiring for good EMC performance.

The maximum lead length on secondary side is 1.5 m. For a good EMC performance keep the LED wiring as short as possible.

Furthermore, the wiring of the individual channels has to be separated and the use of twisted pairs is not recommended.

To avoid the damage of the Driver, the wiring must be protected against short circuits to earth (sharp edged metal parts, metal cable clips, louver, etc.).

Release of the wiring

Loosen wire through twisting and pulling or using a Ø 1 mm release tool.

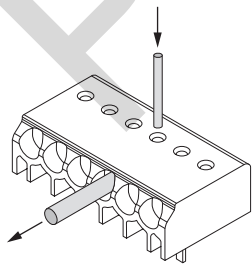

Side fixing feature

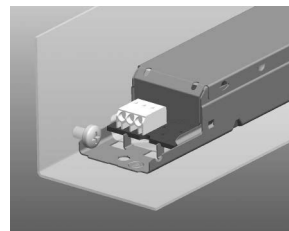

Screw M4, screw head diameter 8–10 mm

Wiring diagram for switchDIM and colourTEMPERATURE for 2-channel LED modules

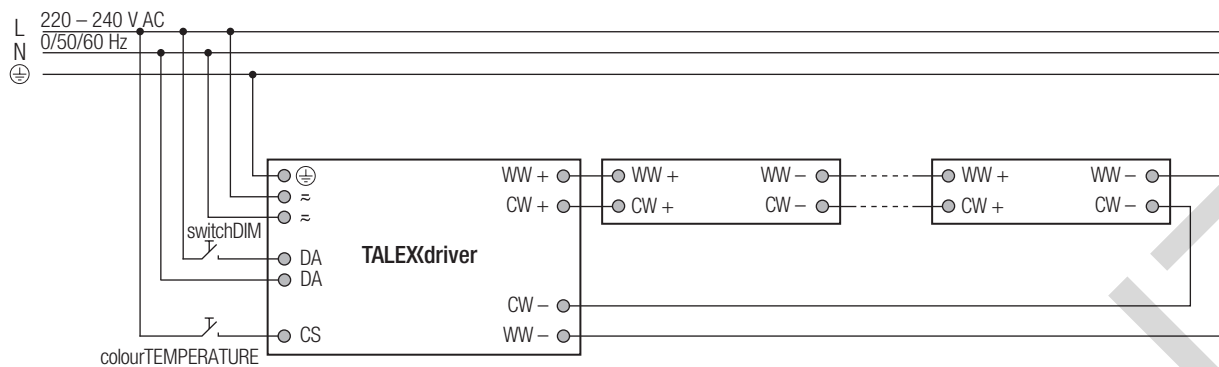

Wiring diagram for DALI for 2-channel LED modules

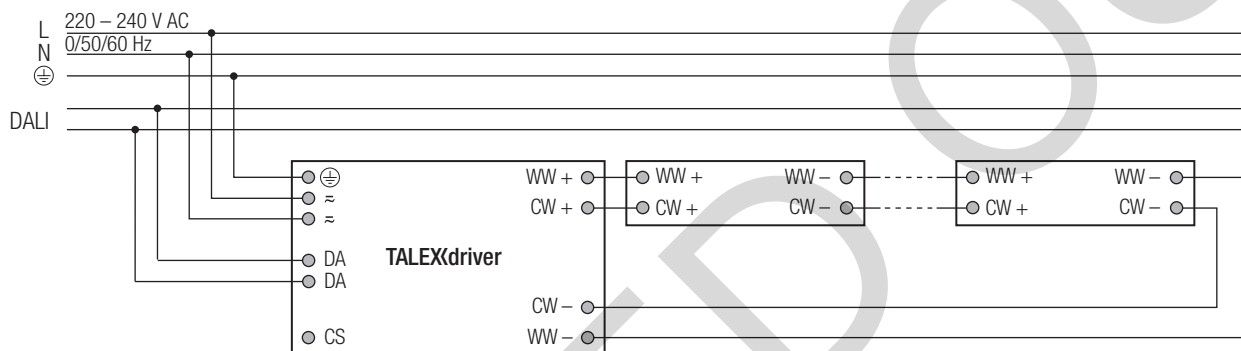

Maximum number of switching cycles

All LED Driver are tested with 50,000 switching cycles.
The actually achieved number of switching cycles is significantly higher.

Additional information

Additional technical information at www.tridonic.com → Technical Data

Guarantee conditions at www.tridonic.com → Services

Life-time declarations are informative and represent no warranty claim.
No warranty if device was opened.