



Driver LC 35W 250/300/350mA fixC Ip ADV ADVANCED series

Product description

- Fixed output constant current built-in LED Driver
- Output current 250, 300 or 350 mA
- Max. output power 35 W
- Nominal life-time up to 50,000 h
- For class I luminaires
- Temperature protection as per EN 61347-2-13 C5e
- 5-year guarantee

Properties

- Low-profile metal casing with white cover
- Type of protection IP20

Functions

- Intelligent Temperature Guard (overtemperature protection)
- Short-circuit proof
- Overload protection
- Burst protection voltage 1 kV
- Surge protection voltage 1 kV (L to N)
- Surge protection voltage 2 kV (L/N to earth)



Standards, page 3





Driver LC 35W 250/300/350mA fixC Ip ADV

ADVANCED series

Technical data

| | |
|--|------------------|
| Rated supply voltage | 220 – 240 V |
| AC voltage range | 198 – 264 V |
| Typ. current (at 230 V, 50 Hz, full load) | 0.19 A |
| Mains frequency | 50 / 60 Hz |
| Overvoltage protection | 300 V AC, 1 h |
| λ (at 230 V, 50 Hz, full load) | 0.95 |
| Leakage current (PE) | < 0.5 mA |
| THD (at 230 V, 50 Hz, full load) | < 20 % |
| Output current tolerance [®] | ± 5 % |
| Typ. current ripple (at 230 V, 50 Hz, full load) | < 3 % |
| Max. output voltage | 250 V |
| Time to light | < 0.5 s |
| Ambient temperature ta | -20 ... +50 °C |
| Dimensions L x W x H | 280 x 30 x 21 mm |

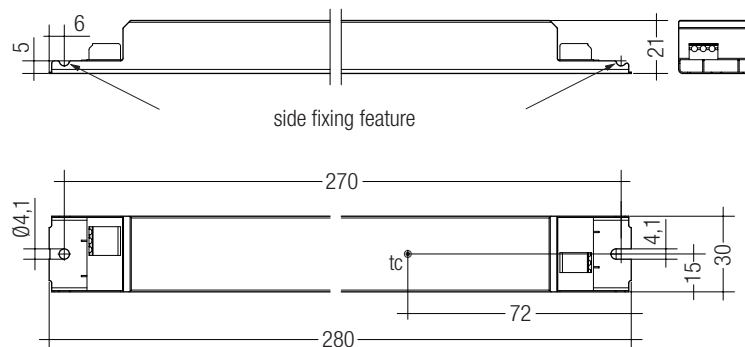

Ordering data

| Type | Article number | Packaging carton | Packaging, low volume | Packaging, high volume | Weight per pc. |
|---------------------------------|-----------------|------------------|-----------------------|------------------------|----------------|
| LC 35W 250mA fixC Ip ADV | 87500453 | 50 pc(s). | 900 pc(s). | 2,700 pc(s). | 0.183 kg |
| LC 35W 300mA fixC Ip ADV | 87500454 | 50 pc(s). | 900 pc(s). | 2,700 pc(s). | 0.183 kg |
| LC 35W 350mA fixC Ip ADV | 87500455 | 50 pc(s). | 900 pc(s). | 2,700 pc(s). | 0.183 kg |

Specific technical data

| Type | Output current [®] | Min. forward voltage | Max. forward voltage | Max. output power | Input power (at 230 V, 50 Hz, full load) | Input current (at 230 V, 50 Hz, full load) | Efficiency (at 230 V, 50 Hz, full load) | Max. peak output current | tc point |
|---------------------------------|-----------------------------|----------------------|----------------------|-------------------|--|--|---|--------------------------|----------|
| LC 35W 250mA fixC Ip ADV | 250 mA | 47 V | 140 V | 35 W | 39.5 W | 190 mA | 90 % | 337.5 mA | 70 °C |
| LC 35W 300mA fixC Ip ADV | 300 mA | 47 V | 117 V | 35 W | 39.5 W | 190 mA | 89 % | 405.0 mA | 70 °C |
| LC 35W 350mA fixC Ip ADV | 350 mA | 45 V | 100 V | 35 W | 39.5 W | 190 mA | 89 % | 472.5 mA | 70 °C |

[®] Output current is mean value.

Standards

EN 55015
 EN 61000-3-2
 EN 61000-3-3
 EN 61347-2-13
 EN 62384
 EN 61547

Overload protection

LED Driver will switch off at overload operation. Mains reset is required to restart the LED Driver.

Overtemperature protection

The LED Driver will reduce output current at temporary thermal over-heating (exceeding max. t_c point).

Short-circuit behaviour

LED Driver will switch off in case of short-circuit of LED output. Mains reset is required to restart the LED Driver.

No-load operation or load loss during operation

LED Driver will detect a load loss during operation. In this case and no-load operation the max. output voltage can apply at the LED output for max. 5 s before LED Driver shuts down. Mains reset is required to restart the LED Driver.

Humidity: 5 % up to max. 85 %,
 not condensed
 (max. 56 days/year at 85 %)

Storage temperature: -40 °C up to max. +80 °C

The devices have to be within the specified temperature range (t_a) before they can be operated.

Expected life-time

| Type | t_a | 40 °C | 50 °C | 60 °C |
|--------------------------|-----------|----------|----------|-------|
| LC 35W 250mA fixC Ip ADV | t_c | 60 °C | 70 °C | x |
| | life-time | 50,000 h | 30,000 h | x |
| LC 35W 300mA fixC Ip ADV | t_c | 60 °C | 70 °C | x |
| | life-time | 50,000 h | 30,000 h | x |
| LC 35W 350mA fixC Ip ADV | t_c | 60 °C | 70 °C | x |
| | life-time | 50,000 h | 30,000 h | x |

x = not permitted

The LED Drivers are designed for a life-time stated above under reference conditions and with a failure probability of less than 10 %.

Maximum loading of automatic circuit breakers

| Automatic circuit breaker type | C10 | C13 | C16 | C20 | B10 | B13 | B16 | B20 | Inrush current | |
|---------------------------------|---------------------|---------------------|---------------------|---------------------|---------------------|---------------------|---------------------|---------------------|----------------|--------|
| Installation Ø | 1,5 mm ² | 1,5 mm ² | 2,5 mm ² | 2,5 mm ² | 1,5 mm ² | 1,5 mm ² | 2,5 mm ² | 2,5 mm ² | I_{max} | time |
| LC 35W 250mA fixC Ip ADV | 24 | 42 | 46 | 54 | 12 | 21 | 23 | 27 | 23.3 A | 168 µs |
| LC 35W 300mA fixC Ip ADV | 24 | 42 | 46 | 54 | 12 | 21 | 23 | 27 | 23.3 A | 168 µs |
| LC 35W 350mA fixC Ip ADV | 24 | 42 | 46 | 54 | 12 | 21 | 23 | 27 | 23.3 A | 168 µs |

Harmonic distortion in the mains supply (at 230 V / 50 Hz and full load) in %

| | THD | 3. | 5. | 7. | 9. | 11. |
|---------------------------------|------|------|-----|-----|-----|-----|
| LC 35W 250mA fixC Ip ADV | < 20 | < 11 | < 5 | < 3 | < 3 | < 2 |
| LC 35W 300mA fixC Ip ADV | < 20 | < 11 | < 5 | < 3 | < 3 | < 2 |
| LC 35W 350mA fixC Ip ADV | < 20 | < 11 | < 5 | < 3 | < 3 | < 2 |

Installation instructions**Wiring type and cross section**

Solid wire with a cross section of 0.5 – 1.5 mm². Strip 8 – 9 mm of insulation from the cables to ensure perfect operation of terminals.

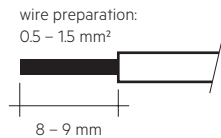
**Release of the wiring**

Loosen wire through twisting and pulling or using a Ø 1 mm release tool.

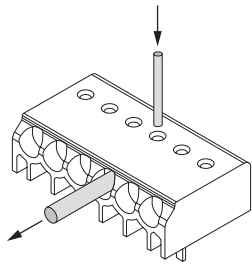
**Wiring guidelines**

- All connections must be kept as short as possible to ensure good EMI behaviour.
- Mains leads should be kept apart from LED Driver and other leads (ideally 5 – 10 cm distance)
- Max. length of output and I sel wires is 2 m.
- Secondary switching is not permitted.
- Incorrect wiring can damage LED modules.
- To avoid the damage of the Driver, the wiring must be protected against short circuits to earth (sharp edged metal parts, metal cable clips, louver, etc.).

Additional information

Additional technical information at www.tridonic.com → Technical Data

Guarantee conditions at www.tridonic.com → Services

Life-time declarations are informative and represent no warranty claim. No warranty if device was opened.

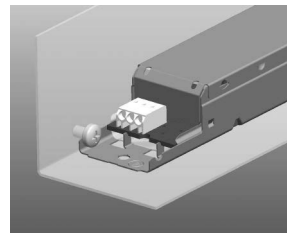
Side fixing feature

Screw M4, screw head diameter 8–10 mm

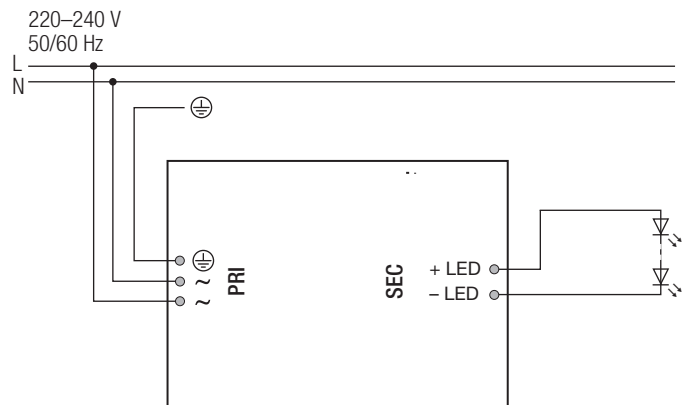
Circuit diagram**Isolation and electric strength testing of luminaires**

Electronic devices can be damaged by high voltage. This has to be considered during the routine testing of the luminaires in production.

According to IEC 60598-1 Annex Q (informative only!) or ENEC 303-Annex A, each luminaire should be submitted to an isolation test with 500 V_{DC} for 1 second. This test voltage should be connected between the interconnected phase and neutral terminals and the earth terminal. The isolation resistance must be at least 2 MΩ.

As an alternative, IEC 60598-1 Annex Q describes a test of the electrical strength with 1500 V_{AC} (or 1.414 x 1500 V_{DC}). To avoid damage to the electronic devices this test must not be conducted.

Diagrams LC 35W 250mA fixC Ip ADV

Efficiency vs load

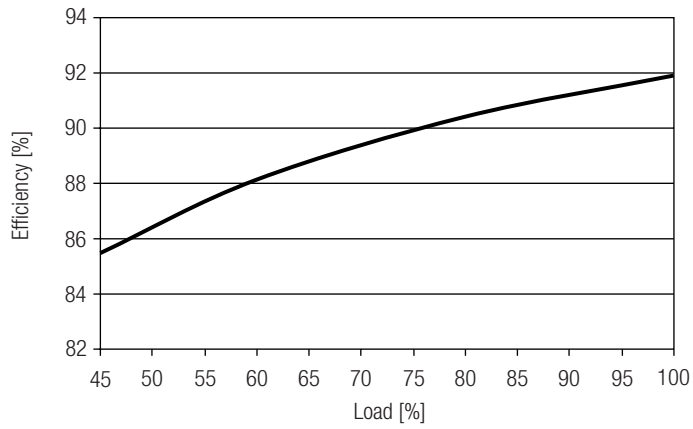

Power factor vs load

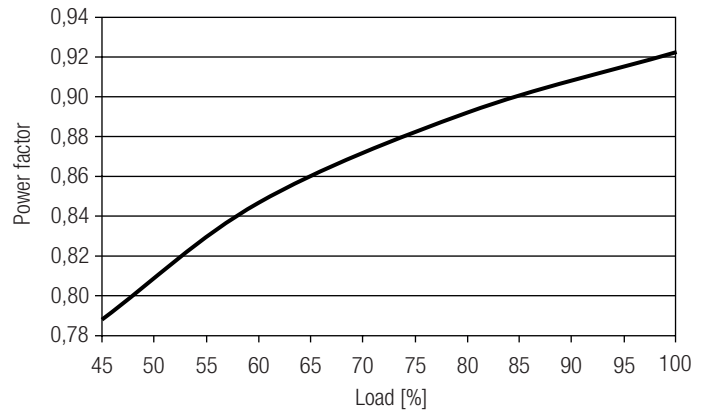

Input power vs load

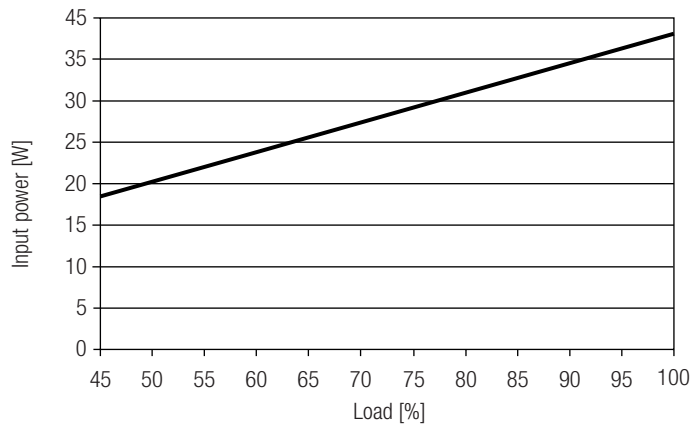

Input current vs load

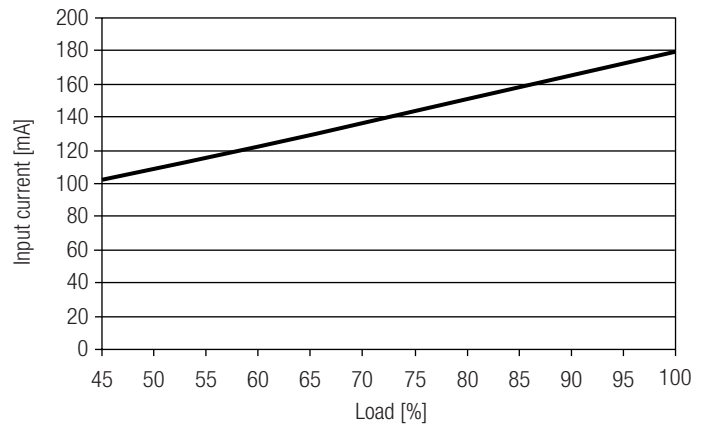

THD vs load

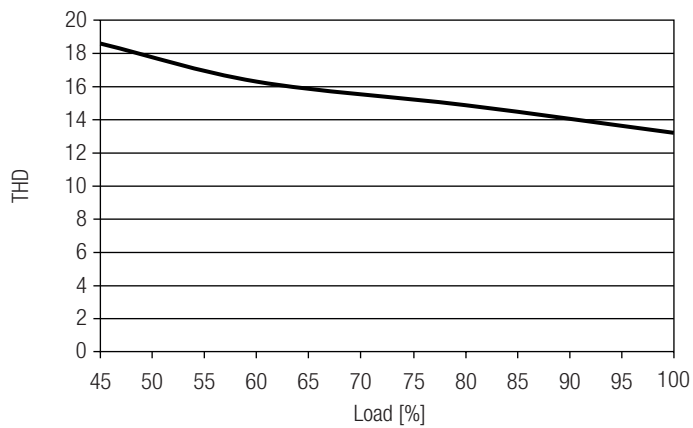

Diagrams LC 35W 300mA fixC Ip ADV

Efficiency vs load

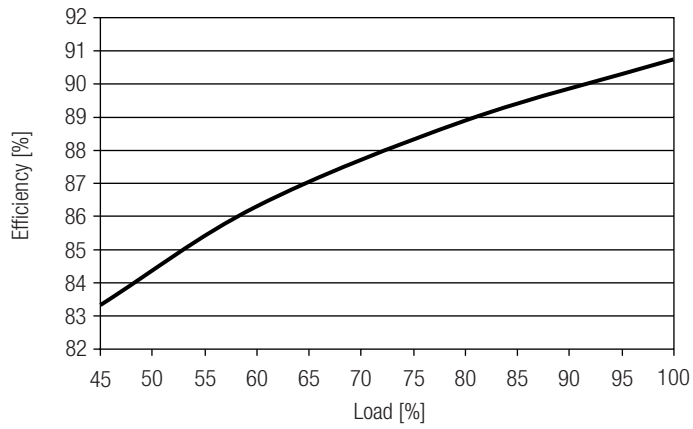

Power factor vs load

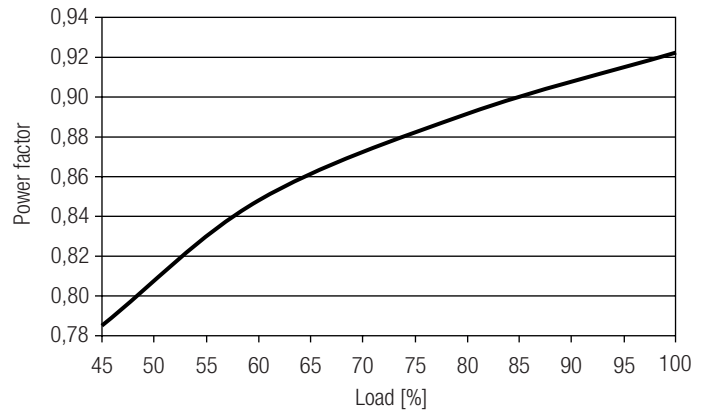

Input power vs load

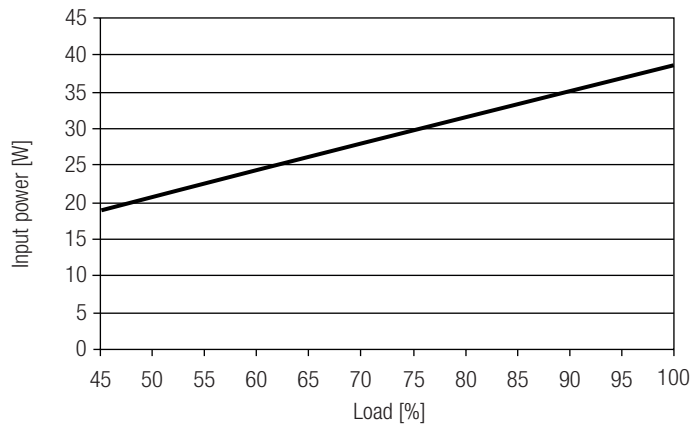

Input current vs load

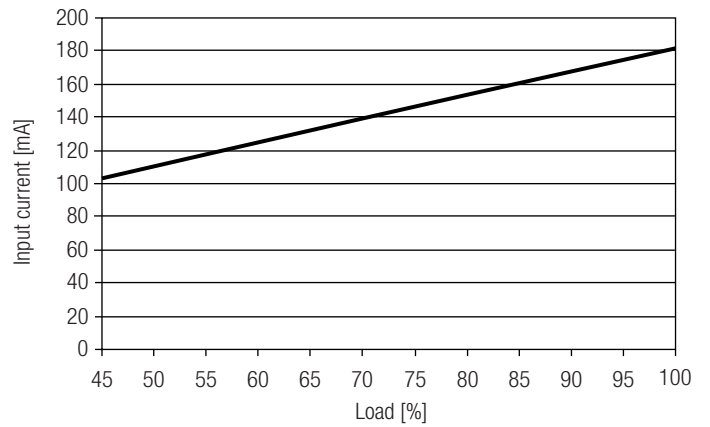

THD vs load

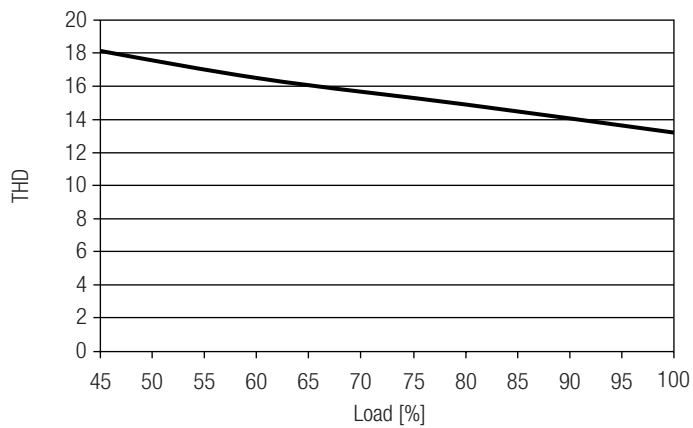

Diagrams LC 35W 350mA fixC Ip ADV

Efficiency vs load

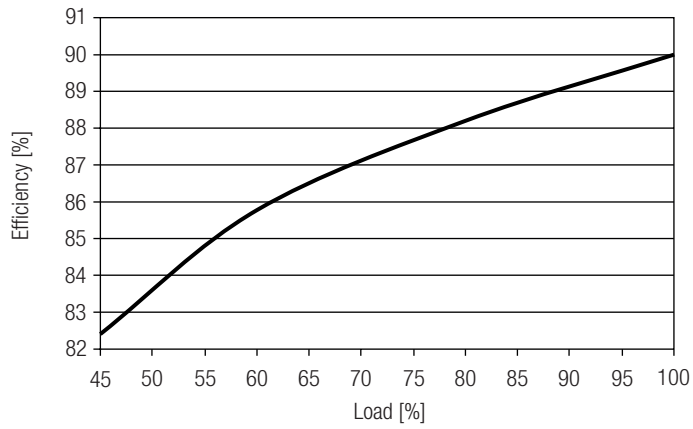

Power factor vs load

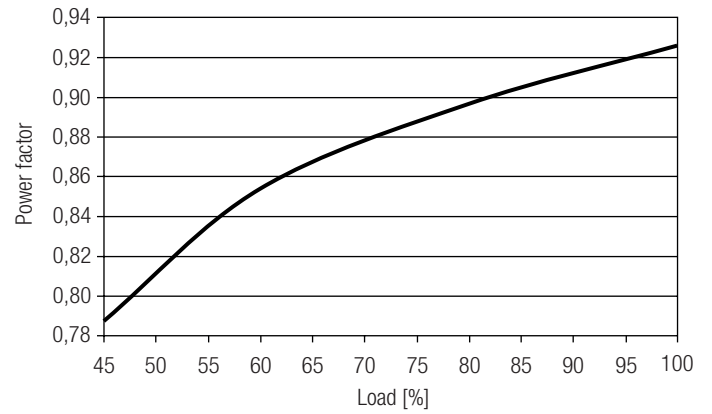

Input power vs load

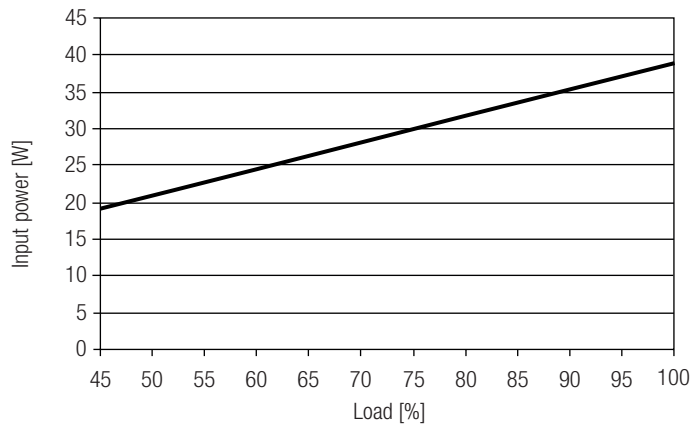

Input current vs load

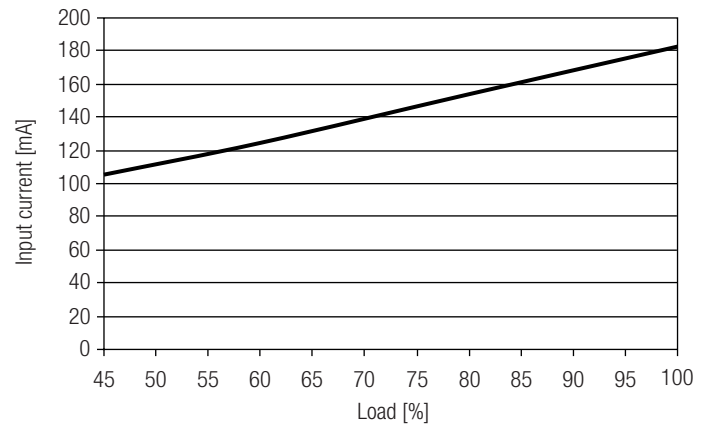

THD vs load

