

IP20 SELV 

## Driver LCI 60 W 700/1050 mA TEC Ip TEC series

### Product description

- Fixed output built-in LED Driver
- Constant current LED Driver
- Output current 700 or 1,050 mA
- Max. output power 60 W
- Nominal life-time up to 50,000 h
- For luminaires of protection class I and protection class II
- Temperature protection as per EN 61347-2-13 C5e
- 5-year guarantee

### Properties

- Low-profile metal casing with white cover
- Type of protection IP20

### Functions

- Overtemperature protection
- Overload protection
- Short-circuit protection
- No-load protection

### Technical data

Rated supply voltage	220 – 240 V
AC voltage range	198 – 264 V
Typ. rated current (at 230 V, 50 Hz, full load)	0.3 A
Mains frequency	50 / 60 Hz
Overvoltage protection	300 V AC, 1 h
Leakage current (at 230 V, 50 Hz, full load)	< 550 µA
Max. input power	70 W
Output power	60 W
THD (at 230 V, 50 Hz, full load)	< 20 %
Output current tolerance <sup>®</sup>	± 7.5 %
Typ. current ripple (at 230 V, 50 Hz, full load)	± 30 %
Turn on time (at 230 V, 50 Hz, full load)	≤ 0.7 s
Turn off time (at 230 V, 50 Hz, full load)	≤ 0.7 s
Hold on time at power failure	0 s
Ambient temperature $t_a$	-20 ... +50 °C
Ambient temperature $t_a$ (at life-time 50,000 h)	40 °C
Storage temperature $t_s$	-40 ... +80 °C
Dimensions L x W x H	360 x 30 x 21 mm

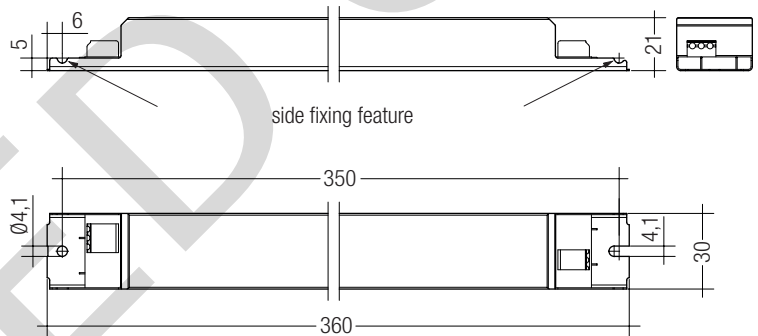

### Ordering data

Type	Article number	Packaging, carton	Packaging, low volume	Packaging, high volume	Weight per pc.
LCI 60W 700mA TEC Ip	87500227	50 pc(s).	650 pc(s).	1,950 pc(s).	0.265 kg
LCI 60W 1050mA TEC Ip	87500228	50 pc(s).	650 pc(s).	1,950 pc(s).	0.255 kg



**Standards**, page 3

**Wiring diagrams and installation examples**, page 4

**Specific technical data**

Type	Output current <sup>①</sup>	Typ. power consumption (at 230 V, 50 Hz, full load)	Power factor at full load <sup>②</sup>	Efficiency at full load <sup>②</sup>	Power factor at min. load <sup>②</sup>	Efficiency at min. load <sup>②</sup>	Min. forward voltage <sup>③</sup>	Max. forward voltage <sup>③</sup>	Max. output voltage	Max. peak output current at full load <sup>②③</sup>	Max. peak output current at min. load <sup>②③</sup>	Max. casing temperature Tc
<b>LCI 60W 700mA TEC Ip</b>	700 mA	65.5 W	0.98	91.5 %	0.93C	90.0 %	46.5 V	85.5 V	98 V	1,060 mA	1,130 mA	70 °C
<b>LCI 60W 1050mA TEC Ip</b>	1,050 mA	66.0 W	0.98	90.5 %	0.93C	89.0 %	31.0 V	57.0 V	62 V	1,610 mA	1,770 mA	75 °C

<sup>①</sup> Test result at 230 V, 50 Hz.

<sup>②</sup> The trend between min. and full load is linear.

<sup>③</sup> Output current is mean value.

PHASED OUT

### Standards

EN 55015  
EN 61000-3-2  
EN 61000-3-3  
EN 61347-1  
EN 61347-2-13  
EN 61547  
EN 62384

### Overload protection

If the output voltage range is exceeded the LED Driver reduces the LED output current. After elimination of the overload the nominal operation is restored automatically.

### Overtemperature protection

The LED Driver is protected against temporary thermal overheating. If the temperature limit is exceeded the output current is reduced to limit  $t_c$  at a certain level. The temperature protection is activated typically at 10 °C above  $t_c$  max.

### Short-circuit behaviour

In case of a short circuit on the secondary side (LED) the LED Driver switches into hic-cup mode. After the removal of the short-circuit fault the LED Driver will recover automatically.

### No-load operation

The LED Driver works in constant voltage mode. In no-load operation the output voltage will not exceed the specified max. output voltage (see page 1).

### Expected life-time

Type	$t_a$	40 °C	50 °C	60 °C
<b>LCI 60W 700mA TEC Ip</b>	$t_c$	60 °C	70 °C	x
	Life-time	50,000 h	30,000 h	x
<b>LCI 60W 1050mA TEC Ip</b>	$t_c$	65 °C	75 °C	x
	Life-time	50,000 h	30,000 h	x

The LED Drivers are designed for a life-time stated above under reference conditions and with a failure probability of less than 10 %.

### Maximum loading of automatic circuit breakers

Automatic circuit breaker type	C10	C13	C16	C20	B10	B13	B16	B20	Inrush current	
									$I_{max}$	Time
Installation Ø	1.5 mm <sup>2</sup>	1.5 mm <sup>2</sup>	1.5 mm <sup>2</sup>	2.5 mm <sup>2</sup>	1.5 mm <sup>2</sup>	1.5 mm <sup>2</sup>	1.5 mm <sup>2</sup>	2.5 mm <sup>2</sup>		
<b>LCI 60W 700mA TEC Ip</b>	20	30	40	50	16	24	32	40	13 A	50 µs
<b>LCI 60W 1050mA TEC Ip</b>	20	30	40	50	16	24	32	40	13 A	50 µs

### Harmonic distortion in the mains supply (at 230 V / 50 Hz and full load) in %

	THD	3.	5.	7.	9.	11.
<b>LCI 60W 700mA TEC C</b>	20	10	1	1	1	1
<b>LCI 60W 1050mA TEC C</b>	20	5	2	1	2	2

### Storage conditions

Humidity: 5 % up to max. 85%, not condensed (max. 56 days/year at 85%)

Storage temperature: -40 °C up to max. +80 °C

The devices have to be within the specified temperature range ( $t_a$ ) before they can be operated.

### Installation instructions

The LED module and all contact points within the wiring must be sufficiently insulated against 0.5 kV surge voltage.  
Air and creepage distance must be maintained.

Replace LED module

1. Mains off
2. Remove LED module
3. Wait for 10 seconds
4. Connect LED module again

Hot plug-in or secondary switching of LEDs is not permitted and may cause a very high current to the LEDs.

### Wiring type and cross section

Solid wire with a cross section of 0.5 – 1.5 mm<sup>2</sup>. Strip 8 – 9 mm of insulation from the cables to ensure perfect operation of terminals.

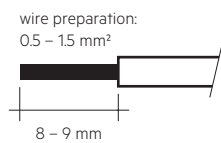

### Wiring diagram

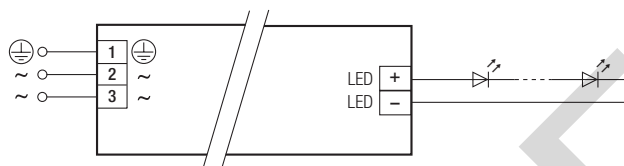

### Wiring guidelines

- All connections must be kept as short as possible to ensure good EMI behaviour.
- Mains leads should be kept apart from LED Driver and other leads (ideally 5 – 10 cm distance)
- Max. length of output wires is 2 m.
- Secondary switching is not permitted.
- Incorrect wiring can damage LED modules.
- The wiring must be protected against short circuits to earth (sharp edged metal parts, metal cable clips, louver, etc.).

### Isolation and electric strength testing of luminaires

Electronic devices can be damaged by high voltage. This has to be considered during the routine testing of the luminaires in production.

According to IEC 60598-1 Annex Q (informative only!) or ENEC 303-Annex A, each luminaire should be submitted to an isolation test with 500 V<sub>DC</sub> for 1 second. This test voltage should be connected between the interconnected phase and neutral terminals and the earth terminal.  
The isolation resistance must be at least 2 MΩ.

As an alternative, IEC 60598-1 Annex Q describes a test of the electrical strength with 1500 V<sub>AC</sub> (or 1.414 x 1500 V<sub>DC</sub>). To avoid damage to the electronic devices this test must not be conducted.

### Release of the wiring

Loosen wire through twisting and pulling or using a Ø 1 mm release tool.

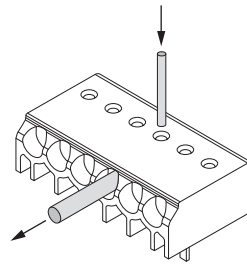

### Side fixing feature

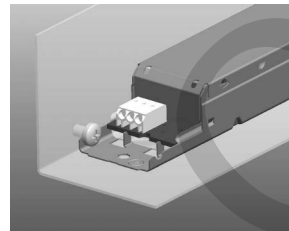

Screw M4, screw head diameter 8–10 mm

### Additional information

Additional technical information at [www.tridonic.com](http://www.tridonic.com) → Technical Data

Guarantee conditions at [www.tridonic.com](http://www.tridonic.com) → Services

Life-time declarations are informative and represent no warranty claim.  
No warranty if device was opened.

Diagrams LCI 60W 700mA TEC Ip

Efficiency vs load

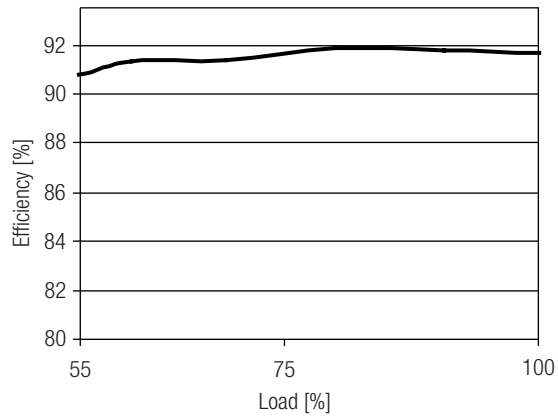

Power factor vs load

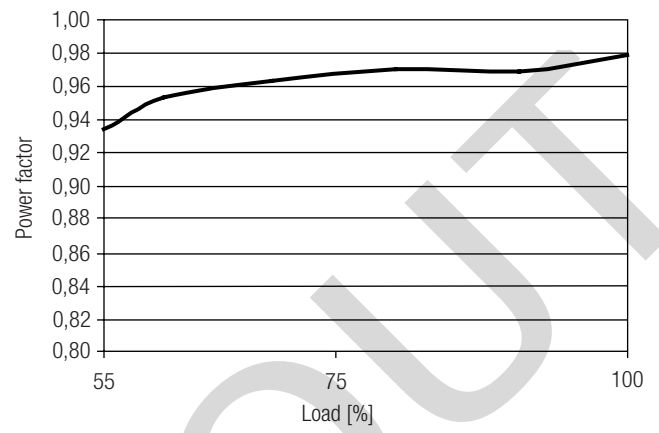

THD vs load

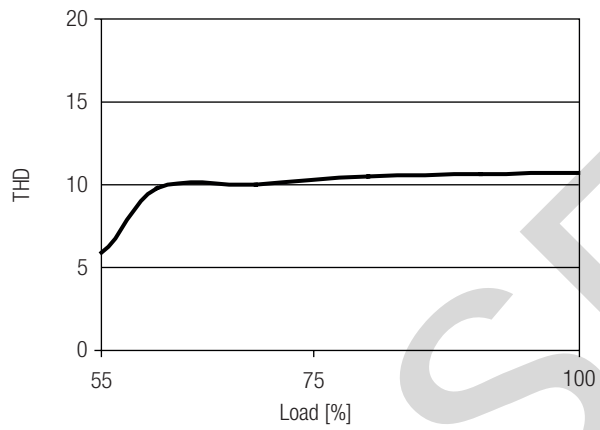

Diagrams LCI 60W 1050mA TEC Ip

Efficiency vs load

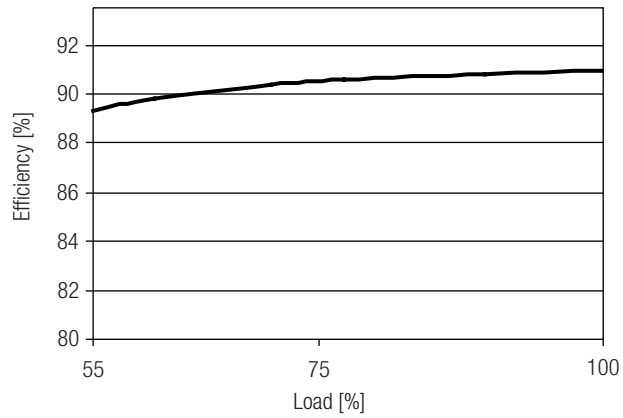

Power factor vs load

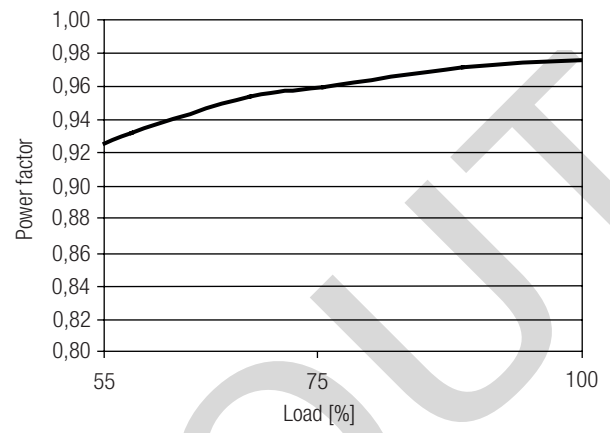

THD vs load

