

Driver LCI 35 W 350/500/700/1050 mA TEC C
TEC series

Product description

- Fixed output built-in LED Driver
- Constant current LED Driver
- Output current 350, 500, 700 or 1,050 mA
- Max. output power 35 W
- Nominal life-time up to 50,000 h
- For luminaires of protection class I and protection class II
- Temperature protection as per EN 61347-2-13 C5e
- 5-year guarantee (conditions at www.tridonic.com)

Properties

- Casing: polycarbonat, white
- Type of protection IP20

Functions

- Overtemperature protection
- Overload protection
- Short-circuit protection
- No-load protection



Standards, page 3

Wiring diagrams and installation examples, page 4

IP20 SELV 

Driver LCI 35 W 350/500/700/1050 mA TEC C

TEC series

Technical data

Rated supply voltage	220 – 240 V
AC voltage range	198 – 264 V
Current at 50 Hz 230 V	0.17 A
Mains frequency	50 / 60 Hz
Overvoltage protection	300 V AC, 1 h
Max. input power	41.5 W
Typ. output power	35 W
THD (at 230 V, 50 Hz, full load)	< 20 %
Output current tolerance ^①	± 7.5 %
Turn on time (at 230 V, 50 Hz, full load)	≤ 0.7 s
Turn off time (at 230 V, 50 Hz, full load)	≤ 0.7 s
Hold on time at power failure (output)	0 s
Ambient temperature t_a	-20 ... +50 °C
Ambient temperature t_a (at life-time 50,000 h)	40 °C
Storage temperature t_s	-40 ... +80 °C
Life-time	up to 50,000 h
Guarantee (conditions at www.tridonic.com)	5 years
Dimensions L x W x H	103 x 67 x 29.7 mm

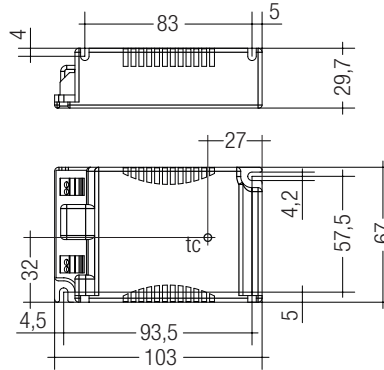

Ordering data

Type	Article number	Packaging, carton	Packaging, low volume	Packaging, high volume	Weight per pc.
LCI 35W 350mA TEC C	87500192	15 pc(s).	345 pc(s).	2,760 pc(s).	0.126 kg
LCI 35W 500mA TEC C	87500194	15 pc(s).	345 pc(s).	2,760 pc(s).	0.127 kg
LCI 35W 700mA TEC C	87500196	15 pc(s).	345 pc(s).	2,760 pc(s).	0.124 kg
LCI 35W 1050mA TEC C	87500198	15 pc(s).	345 pc(s).	2,760 pc(s).	0.129 kg

Specific technical data

Type	Output current ^②	Typ. power consumption (at 230 V, 50 Hz, full load)	λ at full load ^③	Efficiency at full load ^③	λ at min. load ^③	Efficiency at min. load ^③	Min. forward voltage ^③	Max. forward voltage ^③	Max. output voltage	Max. peak output current at full load ^{③②}	Max. peak output current at min. load ^{③②}	Typ. current ripple (at 230 V, 50 Hz, full load)	Max. casing temperature t_c
LCI 35W 350mA TEC C	350 mA	38.5 W	0.98	90.0 %	0.95	88.5 %	50.0 V	100.0 V	115 V	630 mA	850 mA	± 25 %	75 °C
LCI 35W 500mA TEC C	500 mA	38.5 W	0.98	90.0 %	0.95	88.0 %	35.0 V	70.0 V	85 V	800 mA	1,120 mA	± 25 %	80 °C
LCI 35W 700mA TEC C	700 mA	39.0 W	0.99	89.5 %	0.96	86.5 %	25.0 V	50.0 V	63 V	1,170 mA	1,470 mA	± 30 %	80 °C
LCI 35W 1050mA TEC C	1,050 mA	39.5 W	0.98	88.0 %	0.94C	83.0 %	16.5 V	33.5 V	44 V	1,800 mA	2,350 mA	± 30 %	80 °C

^① Test result at 230 V, 50 Hz.

^② The trend between min. and full load is linear.

^③ Output current is mean value.

Standards

EN 55015
EN 61000-3-2
EN 61000-3-3
EN 61347-1
EN 61347-2-13
EN 61547
EN 62384

Overload protection

If the maximum load is exceeded by a defined internal limit, the LED Driver reduces the LED output current. After elimination of the overload the nominal operation is restored automatically.

Overtemperature protection

The LED Driver is protected against temporary thermal overheating. If the temperature limit is exceeded the output current is reduced to limit t_c at a certain level. The temperature protection is activated typically at 8 °C above t_c max.

Short-circuit behaviour

In case of a short circuit on the secondary side (LED) the LED Driver switches into hic-cup mode. After the removal of the short-circuit fault the LED Driver will recover automatically.

No-load operation

The LED Driver works in constant voltage mode. In no-load operation the output voltage will not exceed the specified max. output voltage (see page 1).

Installation instructions

The LED module and all contact points within the wiring must be sufficiently insulated against 4.0 kV surge voltage.

Air and creepage distance must be maintained.

Expected life-time

Type	t_a	40 °C	50 °C	60 °C
LCI 35W 350 mA TEC C	t_c	65 °C	75 °C	x
	Life-time	50,000 h	30,000 h	x
LCI 35W 500 mA TEC C	t_c	70 °C	80 °C	x
	Life-time	50,000 h	30,000 h	x
LCI 35W 700 mA TEC C	t_c	70 °C	80 °C	x
	Life-time	50,000 h	30,000 h	x
LCI 35W 1,050 mA TEC C	t_c	70 °C	80 °C	x
	Life-time	50,000 h	30,000 h	x

The LED Drivers are designed for a life-time stated above under reference conditions and with a failure probability of less than 10 %.

The relation of t_c to t_a temperature depends also on the luminaire design. If the measured t_c temperature is approx. 5 K below t_c max., t_a temperature should be checked and eventually critical components (e.g. ELCAP) measured. Detailed information on request.

Maximum loading of automatic circuit breakers

Automatic circuit breaker type	C10	C13	C16	C20	B10	B13	B16	B20	Inrush current
Installation \varnothing	1.5 mm ²	1.5 mm ²	1.5 mm ²	2.5 mm ²	1.5 mm ²	1.5 mm ²	1.5 mm ²	2.5 mm ²	I_{max} Time
LCI 35W 350mA TEC C	40	60	80	100	30	45	60	70	10 A 100 μ s
LCI 35W 500mA TEC C	40	60	80	100	30	45	60	70	10 A 100 μ s
LCI 35W 700mA TEC C	40	60	80	100	30	45	60	70	10 A 100 μ s
LCI 35W 1050mA TEC C	40	60	80	100	30	45	60	70	10 A 100 μ s

Harmonic distortion in the mains supply (at 230 V / 50 Hz and full load) in %

	THD	3.	5.	7.	9.	11.
LCI 35W 350mA TEC C	20	6	3	2	2	2
LCI 35W 500mA TEC C	20	8	3	2	2	2
LCI 35W 700mA TEC C	20	9	3	3	2	2
LCI 35W 1050mA TEC C	20	10	4	3	2	2

Replace LED module

1. Mains off
2. Remove LED module
3. Wait for 60 seconds
4. Connect LED module again

Hot plug-in or secondary switching of LEDs is not permitted and may cause a very high current to the LEDs.

Glow wire test

according to EN 61347-1 with increased temperature of 850 °C passed.

Mounting of device

Max. torque for fixing: 0.5 Nm/M4

Conditions of use and storage

Humidity: 5 % up to max. 85 %
not condensed
(max. 56 days/year at 85 %)

Storage temperature: -40 °C up to max. +80 °C

The devices have to be within the specified temperature range (t_a) before they can be operated.

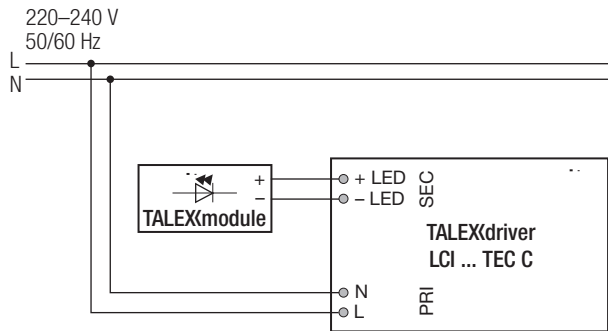
Wiring diagram**Isolation and electric strength testing of luminaires**

Electronic devices can be damaged by high voltage. This has to be considered during the routine testing of the luminaires in production.

According to IEC 60598-1 Annex Q (informative only!) or ENEC 303-Annex A, each luminaire should be submitted to an isolation test with 500 V_{DC} for 1 second. This test voltage should be connected between the interconnected phase and neutral terminals and the earth terminal. The isolation resistance must be at least 2 MΩ.

As an alternative, IEC 60598-1 Annex Q describes a test of the electrical strength with 1500 V_{AC} (or 1.414 x 1500 V_{DC}). To avoid damage to the electronic devices this test must not be conducted.

Maximum number of switching cycles

All LED Driver are tested with 50,000 switching cycles.

Additional information

Additional technical information at www.tridonic.com → Technical Data

Life-time declarations are informative and represent no warranty claim. No warranty if device was opened.

Wiring type and cross section

The wiring can be stranded wires with ferrules or rigid wires with a cross section of 0.5 – 1.5 mm².

Strip 8.5 – 9.5 mm of insulation from the cables to ensure perfect operation of the push-wire terminals (WAGO 250).

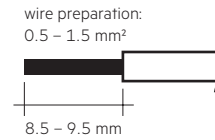
**Wiring instructions**

- All connections must be kept as short as possible to ensure good EMI behaviour
- Mains leads should be kept apart from LED Driver and other leads (ideally 5 – 10 cm distance)
- The maximum length of output wires is 2 m.
- Secondary switching is not permitted.
- Incorrect wiring can damage LED modules.
- To avoid the damage of the Driver, the wiring must be protected against short circuits to earth (sharp edged metal parts, metal cable clips, louver, etc.).

Release of the wiring

Press down the “push button” and remove the cable from front.

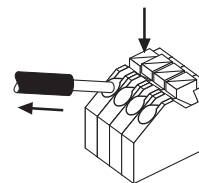

Diagrams LCI 35W 350mA TEC C

Efficiency vs load

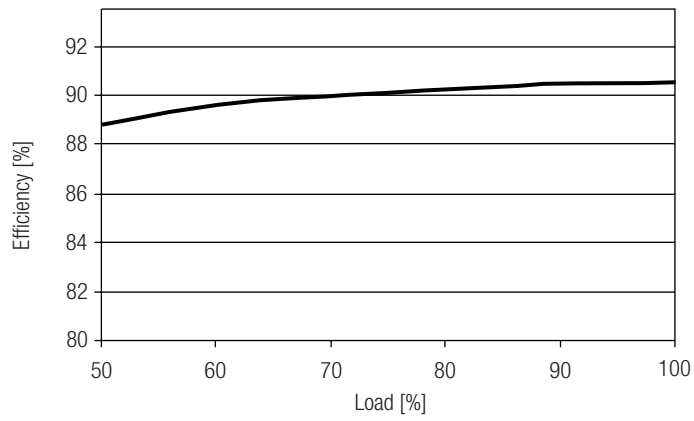

Power factor vs load

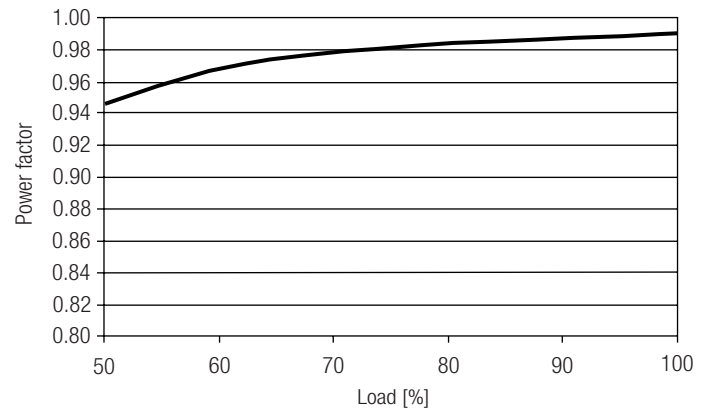

THD vs load

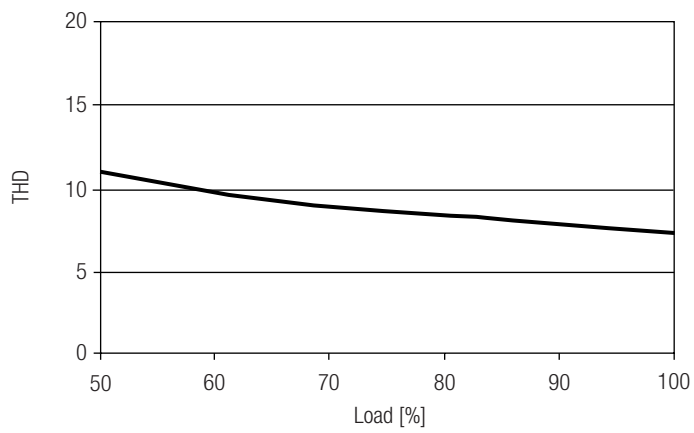

Diagrams LCI 35W 500mA TEC C

Efficiency vs load

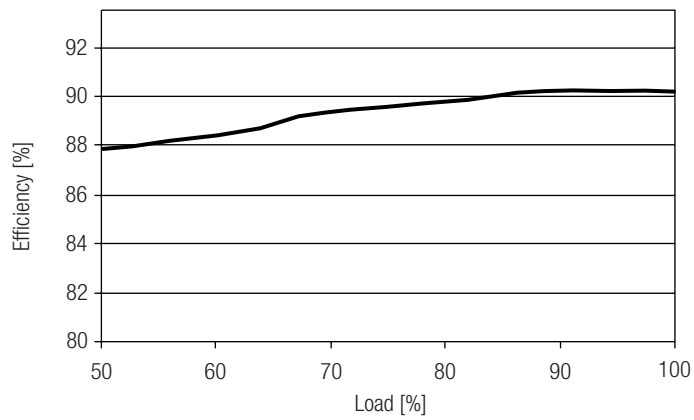

Power factor vs load

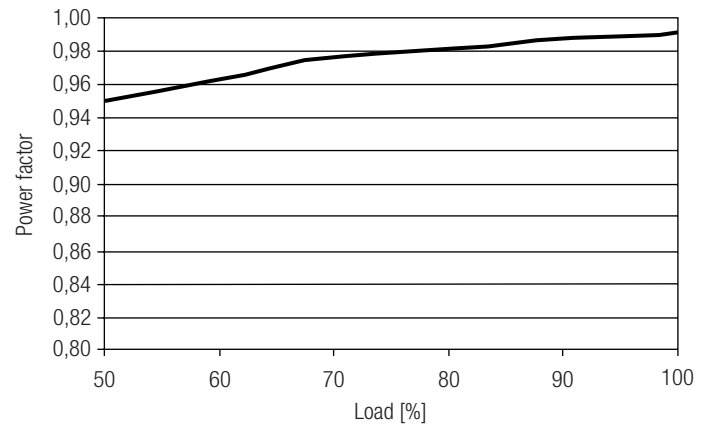

THD vs load

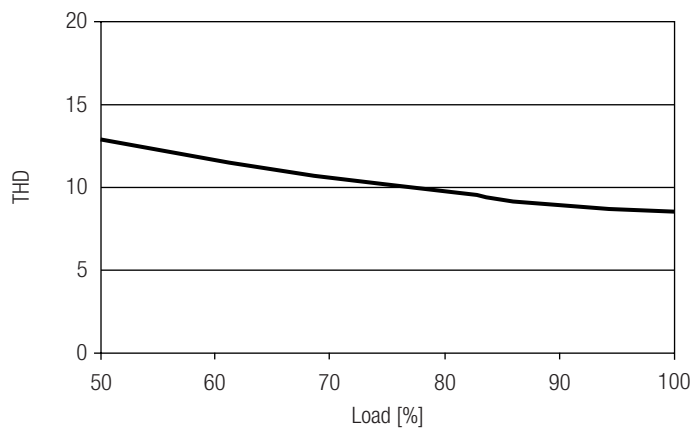

Diagrams LCI 35W 700mA TEC C

Efficiency vs load

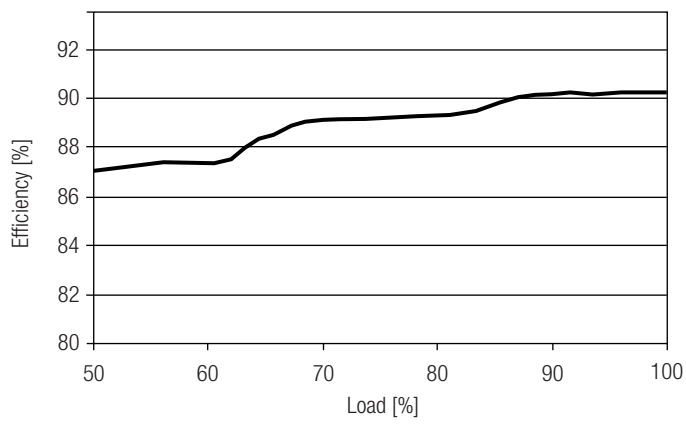

Power factor vs load

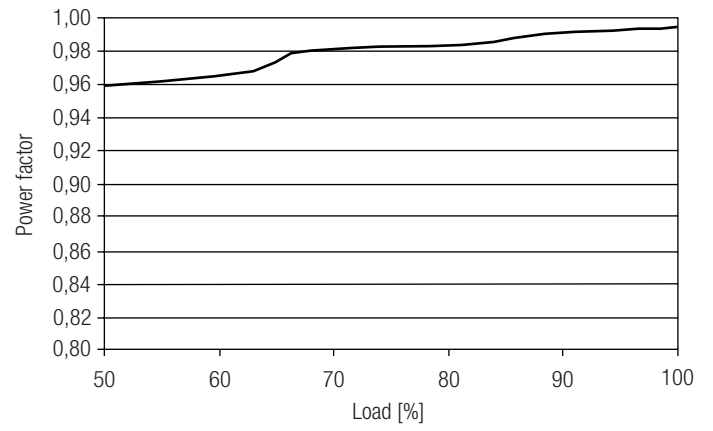

THD vs load

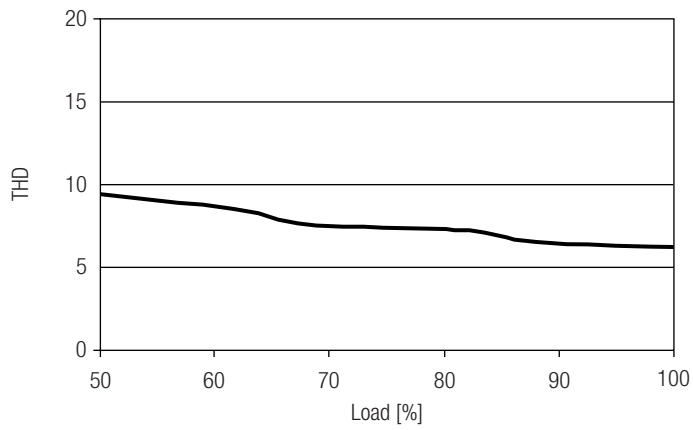

Diagrams LCI 35W 1,050mA TEC C

Efficiency vs load

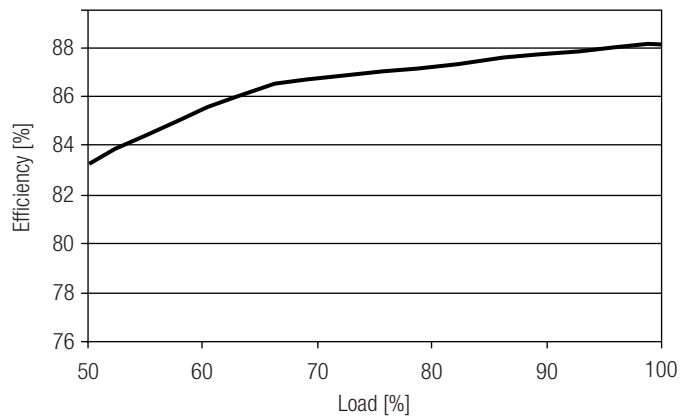

Power factor vs load

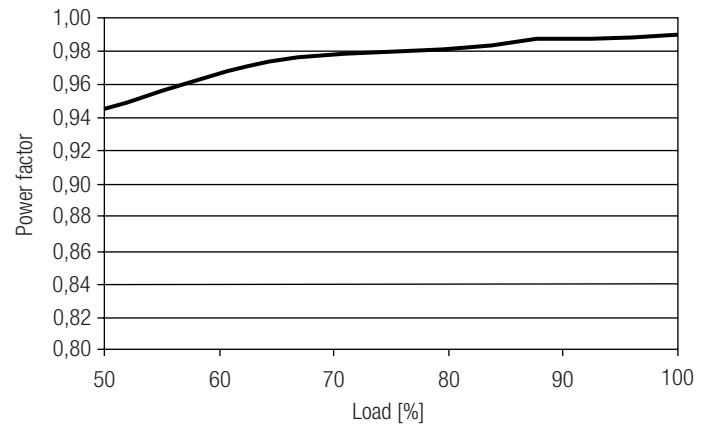

THD vs load

