

Driver LC 60W 24V 0-10V Ip SNC UNV

Constant voltage essence series (US applications)

Product description

- Constant voltage LED Driver
- Universal input voltage range
- Class 2
- Type HL
- UL Listed Class P
- FCC Part 15
- Max. output power 60 W
- Nominal lifetime up to 50,000 h (at ta 45 °C)
- 5 years guarantee (conditions at www.tridonic.com)

Housing properties

- Casing: metal, white
- Dry and damp location

Interfaces

- Dimmable via 0 ... 10 V (incl. stand-by)
- Single wires with tinned wire ends

Functions

- Overtemperature protection
- Overload protection
- Short-circuit protection
- No-load protection



Standards, page 3

Wiring diagrams and installation examples, page 3





Driver LC 60W 24V 0-10V Ip SNC UNV

Constant voltage essence series (US applications)

Technical data

Rated supply voltage	120 – 277 V
AC voltage range	108 – 305 V
Rated current (at 120 V, 60 Hz)	0.6 A
Rated current (at 277 V, 60 Hz)	0.3 A
Leakage current (at 120 V, 60 Hz, full load)	< 500 μ A
Leakage current (at 277 V, 60 Hz, full load)	< 500 μ A
Mains frequency	50 / 60 Hz
Efficiency (at 120 V, 60 Hz)	> 88.0 %
Efficiency (at 277 V, 60 Hz)	> 90.5 %
λ (at 120 V, 60 Hz)	0.98
λ (at 277 V, 60 Hz)	0.95
Typ. power input on stand-by (at 120 V, 60 Hz)	< 0.4 W
Typ. power input on stand-by (at 277 V, 60 Hz)	< 0.4 W
Typ. input current in no-load operation (at 120 V, 60 Hz)	23 mA
Typ. input current in no-load operation (at 277 V, 60 Hz)	37 mA
Typ. input power in no-load operation (at 120 V, 60 Hz)	0.52 W
Typ. input power in no-load operation (at 277 V, 60 Hz)	0.52 W
Output voltage tolerance	22.8 – 25.2 V
Max. output power	60 W
Output power range	0 – 60 W
Output LF voltage ripple (< 120 Hz)	< 500 mV
Starting time (output)	\leq 500 ms
Turn off time (output)	\leq 10 ms
Hold on time at power failure (Output)	\leq 1 ms
THD (at 120 V, 60 Hz, full load) ^①	< 10 %
THD (at 277 V, 60 Hz, full load) ^①	< 20 %
Mains burst capability	1 kV
Mains surge capability (between L – N)	2 kV
Mains surge capability (between L/N – PE)	4 kV
Surge voltage at output side (against PE)	< 500 V
Ambient temperature t_a	-25 ... +55 °C
Ambient temperature t_a (at lifetime 50,000 h)	45 °C
Storage temperature	-40 ... +85 °C
Lifetime	up to 50,000 h
Guarantee (conditions at www.tridonic.com)	5 years
Dimensions LxWxH	148.2 x 45.6 x 25.4 mm
Hole spacing D	4.5 mm

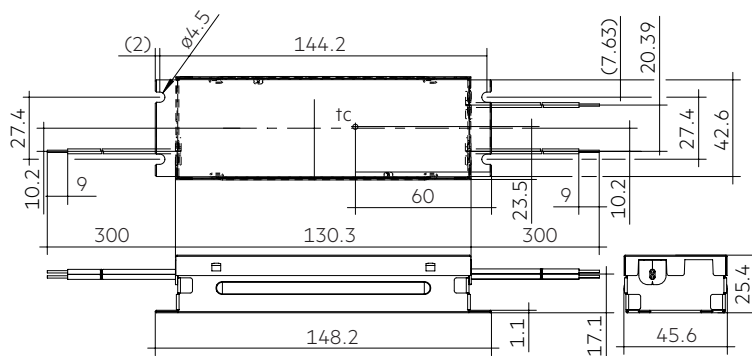

Dimensions in mm

Ordering data

Type	Article number	Packaging carton	Packaging pallet	Weight per pc.
LC 60/24V 0-10V Ip SNC UNV	28003002	20 pc(s).	1,440 pc(s).	0.335 kg

Specific technical data

Type	Max. casing temperature t_c	Output voltage	Max. input power (at 120 V, 60 Hz, full load)	Max. input power (at 277 V, 60 Hz, full load)	Output current range	Max. output voltage ^②
LC 60/24V 0-10V Ip SNC UNV	85 °C	24 V	75 W	70 W	0.0 – 2.5 A	25.2 V

^① Valid at 100 % dimming level.

^② At failure mode.

1. Standards

UL8750 with class 2 output based on UL1310
FCC part 15, Class B

Product not designed for European Economic Area.

This device complies with Part 15 of the FCC Rules. Operation is subject to the following two conditions:

- (1) this device may not cause harmful interference, and
- (2) this device must accept any interference received, including interference that may cause undesired operation.

2. Thermal details and lifetime

2.1 Expected lifetime

Expected lifetime

Type	Output voltage	ta	86 °F (30 °C)	104 °F (40 °C)	113 °F (45 °C)
LC 60/24V 0-10V Ip SNC UNV	24 V	tc	140 °F (60 °C)	158 °F (70 °C)	167 °F (75 °C)
		Lifetime	> 100,000 h	> 75,000 h	> 50,000 h

The LED Driver is designed for a lifetime stated above under reference conditions and with a failure probability of less than 10 %.

The relation of tc to ta temperature depends also on the luminaire design. If the measured tc temperature is approx. 5 K below tc max., ta temperature should be checked and eventually critical components (e.g. ELCAP) measured. Detailed information on request.

3. Installation / Wiring

3.1 Wiring diagram

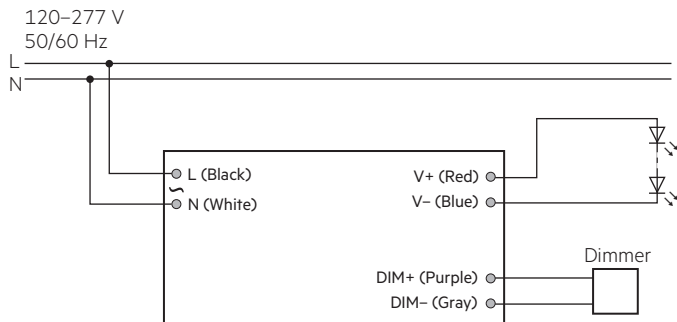

Primary wire		Secondary wire			
L	N	DIM+	DIM-	V+	V-
black	white	purple	gray	red	blue

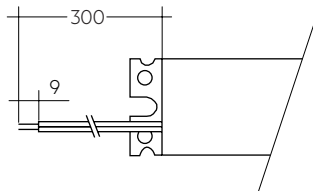

3.2 Wiring type and cross section

The wiring can be in fine-stranded wires with ferrules.
For perfect function of the terminals the strip length should be 9–10 mm for the terminal.

The maximum secondary cable length is 2 m.
The LED wiring should be kept as short as possible to ensure good EMC.

3.3 Wiring guidelines

- All connections must be kept as short as possible to ensure good EMI behaviour.
- Mains leads should be kept apart from LED Driver and other leads (ideally 5 – 10 cm distance)
- Max. length of output wires is 2 m.
- Incorrect wiring can damage LED modules.
- To avoid the damage of the Driver, the wiring must be protected against short circuits to earth (sharp edged metal parts, metal cable clips, louver, etc.).

3.4 Hot plug-in

Hot plug-in or secondary switching of LEDs is not permitted and may cause a very high LED output current.

3.5 Replace LED module

1. Mains off
2. Remove LED module
3. Wait for 20 seconds
4. Connect LED module again

3.6 Earth connection

The earth connection is conducted as protection earth (PE). The LED Driver can be earthed via metal housing. If the LED Driver will be earthed, protection earth (PE) has to be used. There is no earth connection required for the functionality of the LED Driver. Earth connection is recommended to improve following behaviour:

- Electromagnetic interferences (EMI)
- LED glowing at standby
- Transmission of mains transients to the LED output

In general it is recommended to earth the LED Driver if the LED module is mounted on earthed luminaire parts respectively heat sinks and thereby representing a high capacity against earth.

3.7 Installation instructions

The switching of LEDs on secondary side is not permitted. The functioning of the LC in combination with dimming devices (e.g. PWM) cannot be guaranteed and has to be checked individually before using in combination.

4. Electrical values

4.1 Efficiency vs. load

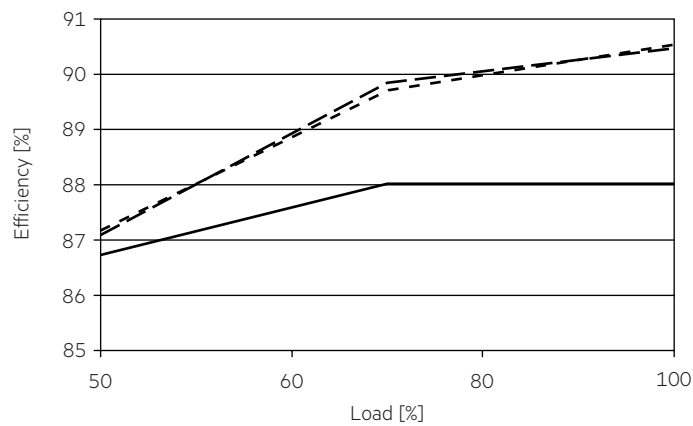

4.2 Power factor vs. load

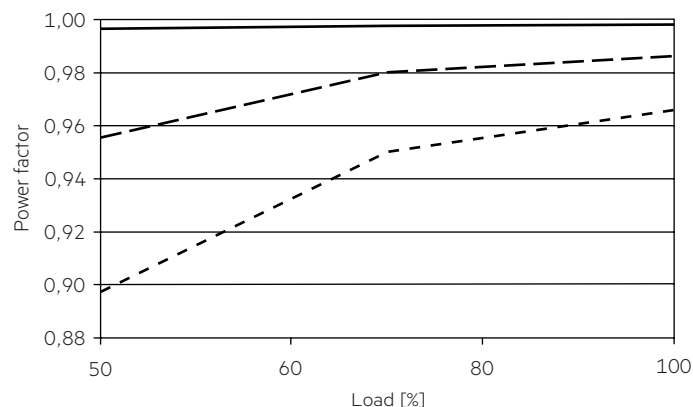

4.3 THD vs. load

THD without harmonic < 5 mA or 0.6 % of the input current.

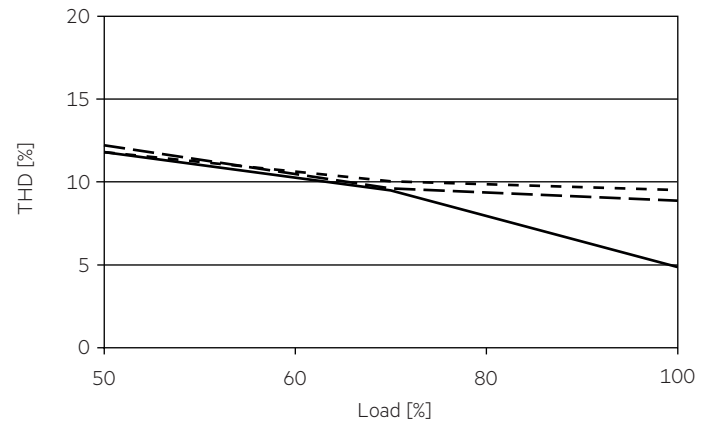

4.4 Input current vs. load

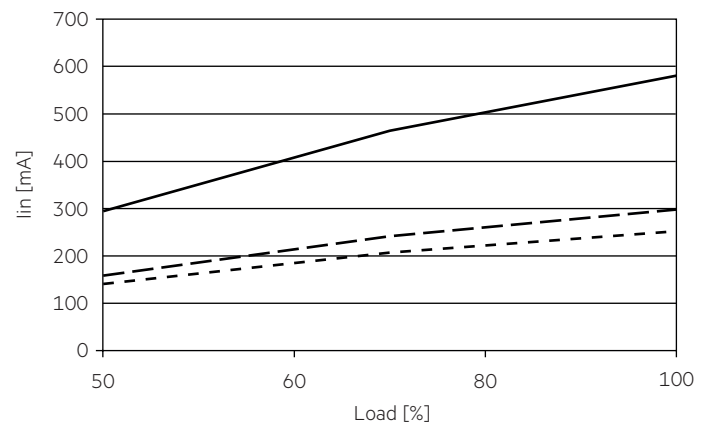

4.5 Input power vs. load

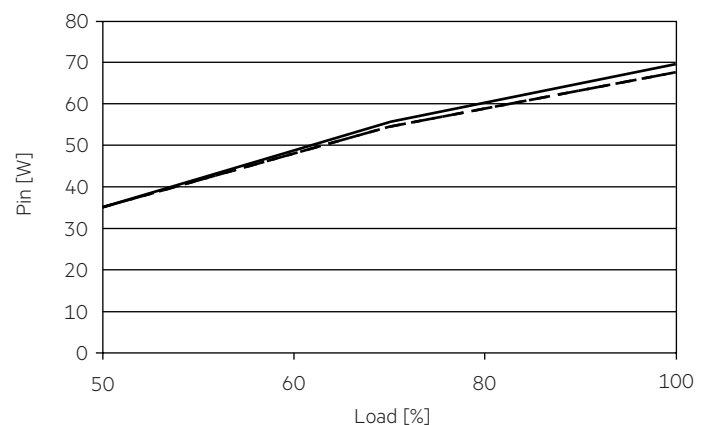

4.6 Dimming

0 – 10 V dimming curve / Output current vs dimming voltage

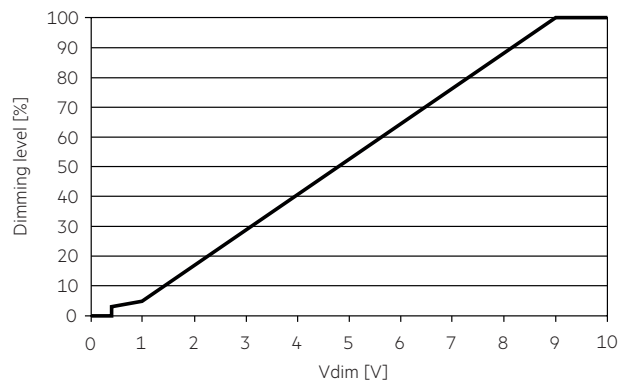

4.7 Maximum loading of automatic circuit breakers

Maximum loading of automatic circuit breakers at 120 V, 60 Hz

Automatic circuit breaker type	C10	C13	C16	C20	B10	B13	B16	B20	Inrush current	
Installation Ø	1.5 mm ²	1.5 mm ²	1.5 mm ²	2.5 mm ²	1.5 mm ²	1.5 mm ²	1.5 mm ²	2.5 mm ²	I _{max}	time
LC 60/24V 0-10V Ip SNC UNV	11	15	18	23	11	15	18	23	16 A	150 µs

Maximum loading of automatic circuit breakers at 230 V, 50 Hz

Automatic circuit breaker type	C10	C13	C16	C20	B10	B13	B16	B20	Inrush current	
Installation Ø	1.5 mm ²	1.5 mm ²	1.5 mm ²	2.5 mm ²	1.5 mm ²	1.5 mm ²	1.5 mm ²	2.5 mm ²	I _{max}	time
LC 60/24V 0-10V Ip SNC UNV	20	26	32	40	14	18	23	25	36 A	150 µs

Maximum loading of automatic circuit breakers at 277 V, 60 Hz

Automatic circuit breaker type	C10	C13	C16	C20	B10	B13	B16	B20	Inrush current	
Installation Ø	1.5 mm ²	1.5 mm ²	1.5 mm ²	2.5 mm ²	1.5 mm ²	1.5 mm ²	1.5 mm ²	2.5 mm ²	I _{max}	time
LC 60/24V 0-10V Ip SNC UNV	18	24	30	37	10	14	18	20	47 A	150 µs

4.8 Harmonic distortion in mains supply in %

120 V, 60 Hz:

Type	THD	3	5	7	9	11
LC 60/24V 0-10V Ip SNC UNV	< 5	< 2	< 1	< 1	< 1	< 1

230 V, 50 Hz:

Type	THD	3	5	7	9	11
LC 60/24V 0-10V Ip SNC UNV	< 9	< 3	< 1	< 1	< 1	< 1

277 V, 60 Hz:

Type	THD	3	5	7	9	11
LC 60/24V 0-10V Ip SNC UNV	< 10	< 2	< 1	< 1	< 1	< 1

Acc. to 6100-3-2. Harmonics < 5 mA or < 0.6 % (whatever is greater) of the input current are not considered for calculation of THD.

5. Interfaces / communication

5.1 Control input (0 ... 10 V)

Control input open	max. dimming level
Interface current range	114 – 126 μ A
Max. permitted input voltage	\pm 15 V
Voltage range dimming	0 – 10 V
Input voltage < 0.4 V	stand-by
Input voltage < 1 V	< 5 %
Input voltage > 10 V	max. dimming level

Interface supports current sink dimmers.

6. Functions

6.1 Short-circuit behaviour

In case of a short circuit on the secondary side (LED) the LED Driver switches off. After elimination of the short-circuit fault the LED Driver will recover automatically.

6.2 No-load operation

The LED Driver will not be damaged in the no-load operation. A voltage of 25.2V DC is permanent at the output.

6.3 Over load protection

If the maximum load is exceeded by a defined internal limit, the LED Driver switches off. After elimination of the short-circuit fault the LED Driver will recover automatically.

6.4 Over temperature protection

Over temperature protection will be activated for $t_a > 60$ °C and $t_c < 110$ °C. The Driver is shut down when over temperature protection triggered. Auto-recovery when fault condition removed.

7. Miscellaneous

7.1 Insulation and electric strength testing of luminaires

Electronic devices can be damaged by high voltage. This has to be considered during the routine testing of the luminaires in production.

According to UL 8750 (informative only!) each luminaire should be submitted to an insulation test with 500 V_{DC}. The dielectric withstand test equipment shall employ a transformer of 500-VA or larger capacity and have a variable output voltage that is essentially sinusoidal or continuous direct current. The applied potential is to be increased from zero at a substantially uniform rate until the required test level is reached, and is to be held at that level for 1 minute.

As an alternative, UL8750 (informative only!) describes a test of the electrical strength with 2V AC + 1000V (or 1.414 x V DC). To avoid damage to the electronic devices this test must not be conducted.

7.2 Conditions of use and storage

Humidity: 10 % up to max. 95 %,
not condensed
(max. 56 days/year at 95 %)

Storage temperature: -40 °C up to max. +85 °C

The devices have to be within the specified temperature range (t_a) before they can be operated.

The LED Driver is declared as inbuilt LED controlgear, meaning it is intended to be used within a luminaire enclosure.

If the product is used outside a luminaire, the installation must provide suitable protection for people and environment (e.g. in illuminated ceilings).

7.3 Maximum number of switching cycles

All LED Driver are tested with 50,000 switching cycles.

7.4 Additional information

Additional technical information at www.tridonic.com → Technical Data

Lifetime declarations are informative and represent no warranty claim. No warranty if device was opened.