



DSI-V/T

Control module for amplifying DSI signals

Product description

- Multi-functional DSI controller
- For amplifying the DSI signal for a maximum of 50 DSI devices or for cascading long lines
- Special function for tunnel applications
- Function can be set via DIP switches
- Input for manual dimming
- Input for presence sensor or momentary-action switch for scene recall
- Different motion sensor functions can be set
- One scene can be set and recalled
- 5-year guarantee



Technical data

Rated supply voltage	120 – 277 V
Mains frequency	50 / 60 Hz
Power	1 W
Ambient temperature t_a	-25 ... +60 °C
Type of protection	IP20



Standards, page 3

Wiring diagrams and installation examples, page 4, 5

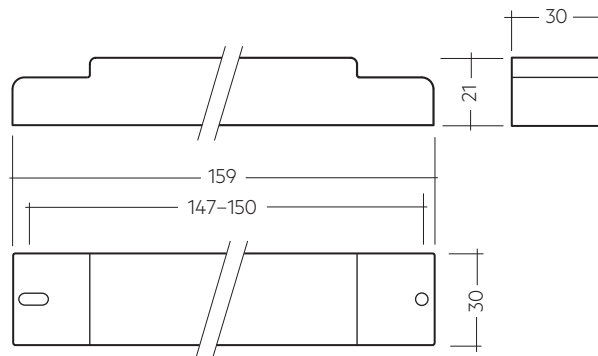

Ordering data

Type	Article number	Packaging carton	Weight per pc.
DSI-V/T	28000882	10 pc(s).	0.068 kg

Specific technical data

Type	Inputs				Outputs	
	Dimming switch	Motion sensor	DSI signal [Ⓜ]	Digital control line DSI	Control output per physical output (devices)	Max. DSI cable length at 1.5 mm ² [Ⓜ]
DSI-V/T	1-way / 2-way	1	1	1	50	250 m

[Ⓜ] Max. cable length in tunnel/security mode = 500 m (DSI-V function only)

[Ⓜ] One DSI-V/T corresponds to the DSI load of two DSI devices.

Strain-relief set

Product description

- Strain relief for up to 3 cables suitable for cable with diameter from 2.5 up to 9 mm
- A: 2.5 – 5 mm diameter
- B: 5 – 9 mm diameter
- C: 5 – 9 mm diameter
- 5-year guarantee

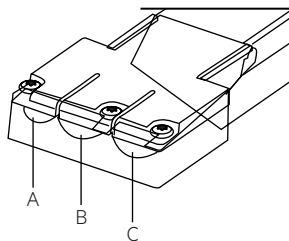
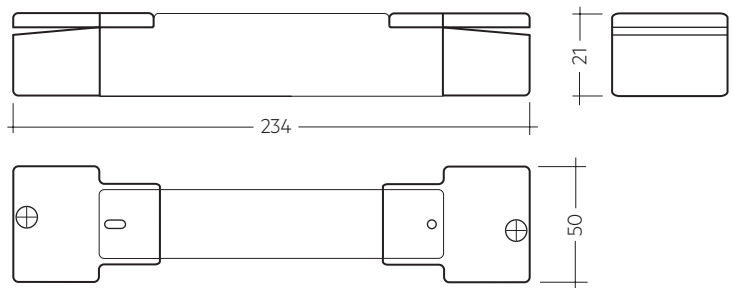

Ordering data

Type	Article number	Packaging carton
Strain-relief set	28000881	10 pc(s).

The digital DSI control module is designed to control up to 50 digital units such as electronic control gear, transformers and phase dimmers. It therefore has all the properties shared by all DSI units so far and enables PCA/TE one4all/PCD digital electronic control gear to be automatically switched and controlled via the control line.

The compact DSI-V/T digital control module is a recent addition to the portfolio. Thanks to its ease of use with DIP switches, it is designed to cover the following functions and applications:

Amplifier function (DSI-V)

The DSI-V/T control module amplifies and synchronises the DSI signal. By regenerating the signal it is possible to operate several control modules one after the other, making this the perfect solution for tunnels. The DSI-V/T has a memory that stores the last DSI value in the event of a power failure. If, for example, a unit is in standby mode (DSI value = 0), this state is retained even after a power failure.

Switch control function (DSI-T)

For switch control the following functions are implemented:

- PD on/off
- PD only off
- PD never off
- Scene

The DSI-V/T control module can be configured as a switch control module with the aid of the built-in DIP switches. This makes the DSI-V/T ideal for manual dimming, ON/OFF switching and calling up presets (defined dimming levels) using conventional one-way and two-way switches. Any number of switches can be connected to the DSI-V/T in parallel so it can be operated from different places.

smartDIM (function)

PD on/off, PD only off, PD never off, Scene.

By connecting a presence detector PCA/TE one4all/ PCD digital electronic control gear can be switched automatically via the control lines.

DSI-PC (function)

The DSI-V/T control module can also be configured as a hardware interface for winDIM software. It can then be used to control up to 50 digital dimmable ECGs from a PC.

DSI-Tunnel (function)

Safety mode specifically for tunnel applications.

If a DSI signal is not received within a period of 60 seconds, the DSI-V/T will fade up to 100% brightness in 60 seconds. A DSI value of 0 is forwarded only if the signal is received three times in succession (this enhances the fault tolerance of the system). This makes it difficult to switch off the system inadvertently. Fault reporting is also suppressed.

Terminal arrangement

Terminals: Rigid wire 0.5 – 1.5 mm²

<input type="checkbox"/> L	120-277V 50/60Hz	luxCONTROL © DSI-V/T	0.5 - 1,5mm ² one solid wire only	<table border="1"> <tr> <td>Standard</td> <td>PC</td> <td>Tunnel</td> </tr> <tr> <td><input type="checkbox"/></td> <td><input type="checkbox"/></td> <td><input type="checkbox"/></td> </tr> </table>	Standard	PC	Tunnel	<input type="checkbox"/>	<input type="checkbox"/>	<input type="checkbox"/>	DSI output max. 50 DSI devices	D1 <input type="checkbox"/>
Standard	PC				Tunnel							
<input type="checkbox"/>	<input type="checkbox"/>	<input type="checkbox"/>										
<input type="checkbox"/> N	Ta: -25 ... 60°C Tc: 70°C	18-9mm	<table border="1"> <tr> <td>P.D. on/off</td> <td>P.D. only off</td> <td>P.D. never off</td> <td>Scene</td> </tr> <tr> <td><input type="checkbox"/></td> <td><input type="checkbox"/></td> <td><input type="checkbox"/></td> <td><input type="checkbox"/></td> </tr> </table>	P.D. on/off	P.D. only off	P.D. never off	Scene	<input type="checkbox"/>	<input type="checkbox"/>	<input type="checkbox"/>	<input type="checkbox"/>	D2 <input type="checkbox"/>
P.D. on/off	P.D. only off	P.D. never off	Scene									
<input type="checkbox"/>	<input type="checkbox"/>	<input type="checkbox"/>	<input type="checkbox"/>									
<input type="checkbox"/> ↑	The same phase conductor has to be used for PTM (push to make switch)	D000 0000 0000000	<table border="1"> <tr> <td>123</td> </tr> <tr> <td><input type="checkbox"/></td> </tr> </table>	123	<input type="checkbox"/>	DSI input only for DSI-V functions	D1 <input type="checkbox"/>					
123												
<input type="checkbox"/>												
<input type="checkbox"/> ↓	Art.-No.: 28000882	D2 <input type="checkbox"/>										
<input type="checkbox"/> PD/SCENE		TRIDONIC										

Cable types

Standard installation and wiring material is used. According to DIN VDE 0100/ T520/Part 6, main circuits and associated auxiliary circuits may be laid together even if the auxiliary circuits carry a lower voltage than the main circuits. Make sure to use cable designed to take the maximum operating voltage.

Cable lengths

	0.5 mm ²	0.75 mm ²	1.5 mm ²
Built-in ceiling/luminaire modules	125 m	125 m	250 m
DSI signal amplifier (DSI-V)	125 m	125 m	250 m

A twisted or stranded 2-core cable approved for low-voltage systems is used as the bus line (2x1.5 mm² is recommended). The cables are not shielded. One twist per metre is recommended; on per 5 metres is the minimum.

e.g.:

H 05 VV-U 2x0.75 (NYM 2x0.75 mm² twisted)

H 05 VV-U 2x1.5 (NYM 2x1.5 mm² twisted)

J-Y(ST)Y tested to 4 kV

PYCYM 2 x 2 x 0.8 (diameter). Note: this corresponds to 2 x 2 x 0.5 mm²

Regulations, approvals & standards

The DSI-V/T complies with the following standards:

- EN 61347-2-11 Special requirements for different electrical circuits for luminaires
 - EN 55015 EMC limit values for radio interference
 - EN 61547 Equipment for general lighting purposes, EMC immunity
- CE conformity with the above standards is declared.

DSI specification V2.0 dated 20.7.01

Glow-wire test

according to EN 61347-1 passed.

Functional description

DSI V/T has two basic functions.

Function selection DSI-V/T

DIP switch (1) for selecting DSI-V or DSI-T

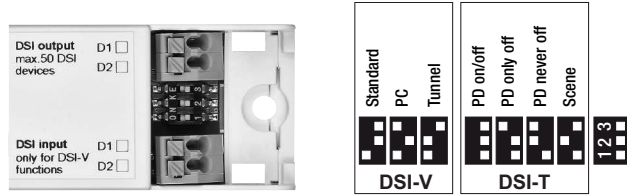

DIP switch settings

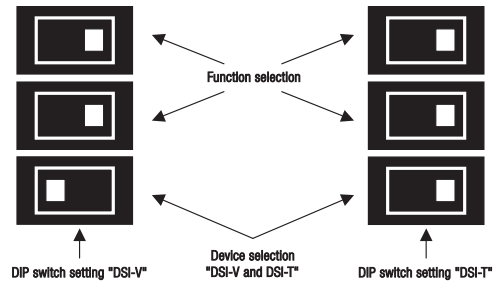

DSI-V function

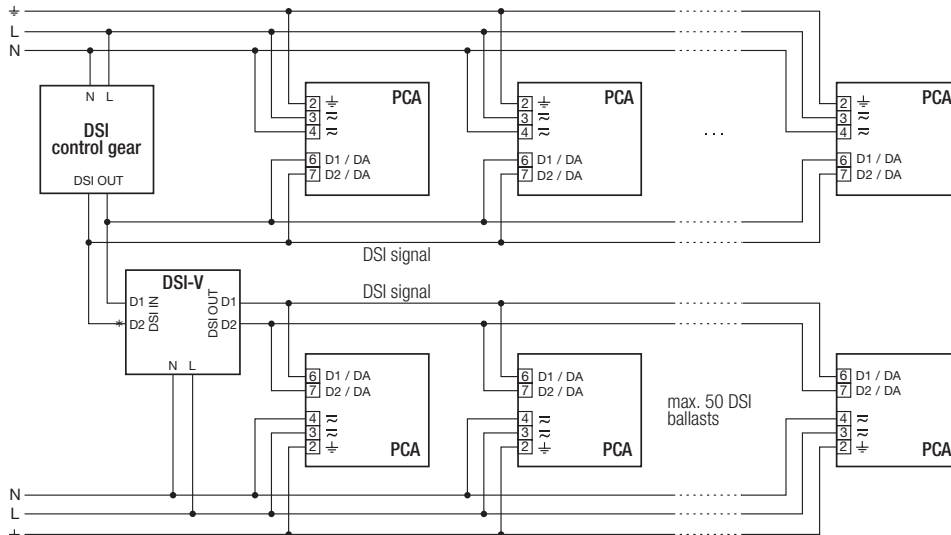
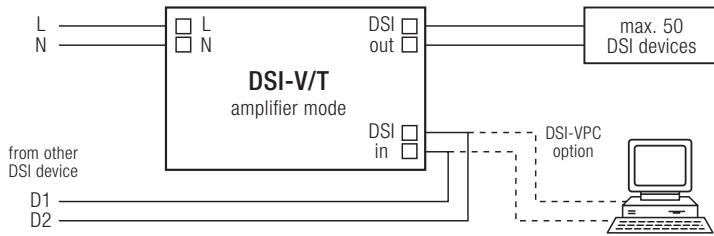

* One DSI-V/T corresponds to the DSI load of two DSI devices.

Cable length:

Cable lengths of up to 500 m can be achieved by concatenating individual DSI-V/Ts. This maximum cable length can only be guaranteed in DSI-V mode if the DSI-V/T is operated as the only load, otherwise the maximum cable length is 250 m for a 1,5 mm² cable.

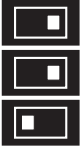

Standard function

- Standard:
The DSI signal is received, amplified (signal amplitude), refreshed (on a time basis) and output again.

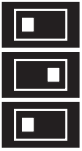

PC function

- PC:
The return channel is deactivated at the input for connection of the serial RS232 interface of winDIM.

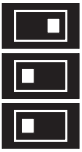

Tunnel function

- Safety mode specifically for tunnel applications.
If a DSI signal is not received within a period of 60 seconds, the DSI-V/T will fade up to 100 % brightness. A DSI value of 0 is forwarded only if the signal is received three times in succession (this enhances the fault tolerance of the system). This makes it difficult to switch off the system inadvertently. Fault reporting is also suppressed.

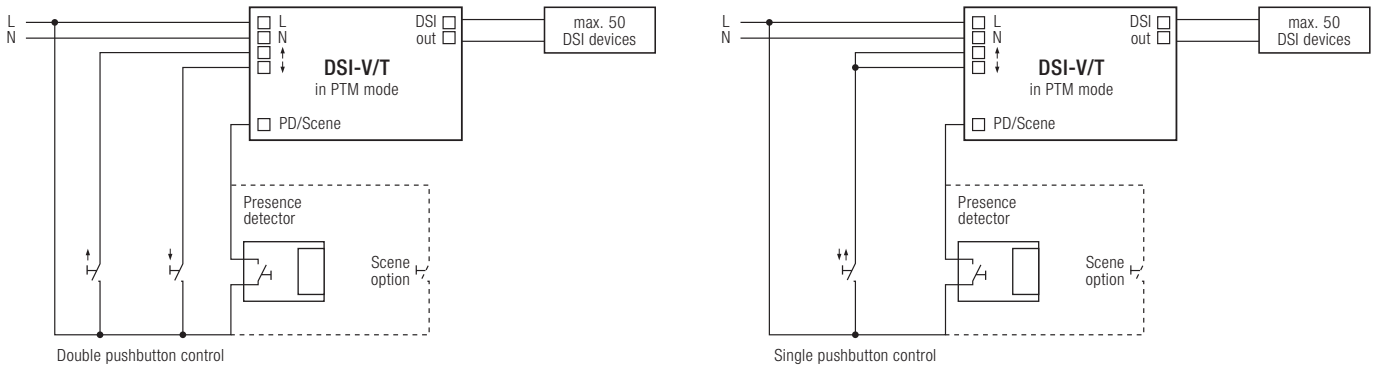

DSI-T function

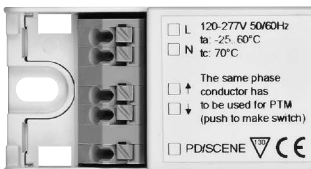

Caution:

If the DSI-V/T is operated on a three-phase system, the switches must be connected to the same phase as the feed (L) of the DSI-V/T.

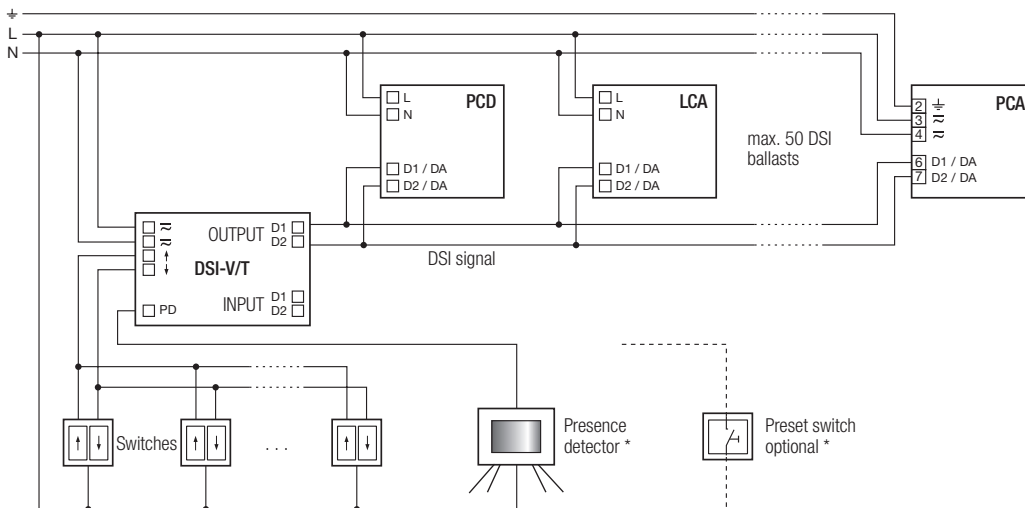

* Either control with presence detector or scene control via switches.

With the DSI-T function selection, user-friendly dimming and ON/OFF switching using commercially available mains voltage switches (one-way or two-way) is possible.

Any number of switches can be connected to the DSI-V/T in parallel so it can be operated from different places (see diagram above). DSI-V/T has a dimming value memory (memory function). Whenever the lighting system is switched on or whenever power returns after a power failure the last light value set before the system was switched off is activated. If, for example, a unit is in standby mode (DSI value = 0), this state is retained even after a power failure.

Double pushbutton control

Short press ↑ or ↓ Switch on or off depending on light setting (50 – 600 ms)
 Long press ↑ Fade up (brighter) (> 600 ms)
 Long press ↓ Fade down (darker) (> 600 ms)

Single pushbutton control

Short press ↑↓ Switch on or off depending on light setting (50 – 600 ms)
 Long press ↑↓ Switch between brighter or darker (> 600 ms)
 Fade rate switch: 4.5 s over the entire fade range

Synchronisation function

If several DSI-V/Ts are connected to a switch in DSI-T mode, the outputs may no longer operate in synchronism. Synchronisation is established by a long press of more than 10 seconds.

→ The light level to which the units are synchronised is then 50 %.

DIP switch settings

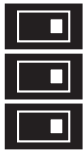

PD on/off (Presence Detection) function

- The PD input is closed:
The lighting is switched on immediately. The DSI value fades to the memory value.
- The PD input is opened:
The lighting fades down and switches off with a fade time of **60 seconds** (for a DSI value of 255).

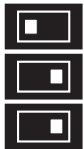

PD only off (Presence Detection)

- The PD input is closed:
The lighting is switched on immediately. The DSI value fades to the memory value.
- The PD input is opened:
The lighting fades down and switches off with a fade time of **60 seconds** (for a DSI value of 255). If the presence detector now detects activity again and therefore closes the PD input, the lighting will still remain dark. The lighting can only be switched on by means of the external switch. If this switch is now actuated the lighting will fade up to the last DSI value set.

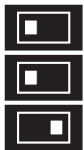

PD never off (Presence Detection)

- The PD input is closed:
The lighting is switched on. The lighting fades up to the last DSI value set.
- The PD input is opened:
The lighting fades down to 3%; it is not switch off. ON/OFF switching is possible only with the one-way/two-way switch.
Fade time = 4 seconds (for a DSI value of 255)



Scene function

- The PD input is closed:
A switch for retrieving scenes is connected to the PD input.

Saving a scene

- Long press (> 10 seconds):
The current DSI value is saved as the memory value.
- This is signalled by double flashing for 0.7 seconds (min.-max.-min.-max.).

Retrieving a scene

- Short press (50 – 600 ms):
The saved scene (memory value) is retrieved.

Note

- After a power failure, the last scene value to be stored is sent back to the ECG when power returns (function: memory value).

Additional information

Additional technical information at www.tridonic.com → Technical Data

Guarantee conditions at www.tridonic.com → Services

Life-time declarations are informative and represent no warranty claim.
No warranty if device was opened.