

ACL LENS 55x280mm
Zubehör Linear

Produktbeschreibung

- ACL LENS für LLE 55x280mm
- Verfügbar in verschiedenen Abstrahlcharakteristiken
- Nur für SELV-Anwendungen
- Einfache Montage mit M4 Schrauben
- ACL SHADE reduziert UGR
- ACL LENS aus PMMA, ACL SHADE aus ABS
- Photometrische Daten verfügbar über Webseite



Lichtverteilungskurven, Seite 3



ACL LENS 55x280mm 60°



ACL LENS 55x280mm DA25°

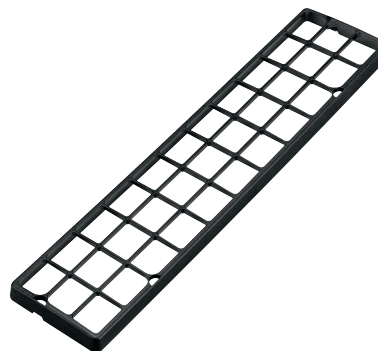

ACL SHADE 55x280mm UGR

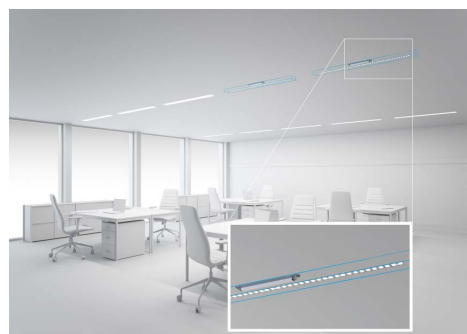

ACL LENS 55x280mm

Zubehör Linear

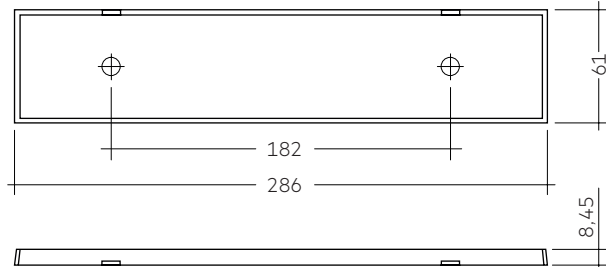

ACL LENS (28002206, 28002207, 28002208)

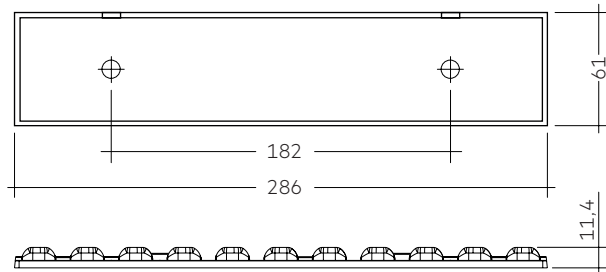

ACL LENS (28002209, 28002210)

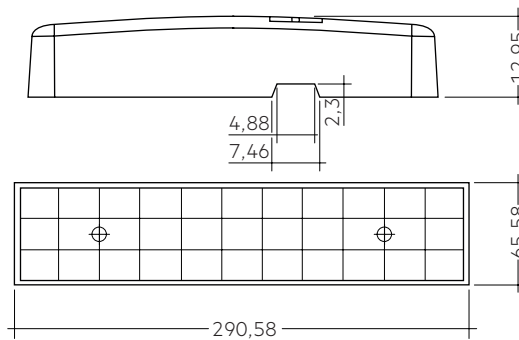

ACL SHADE (28002211)

Bestelldaten

Typ	Artikel- nummer	Abstrahlcharakteristik	Wirkungsgrad	Verpackung Karton	Gewicht pro Stk.
ACL LENS 55x280mm 60°	28002206	60°	91 %	72 Stk.	0,088 kg
ACL LENS 55x280mm 90°	28002207	90°	90 %	72 Stk.	0,092 kg
ACL LENS 55x280mm 90x45°	28002208	90x45°	90 %	72 Stk.	0,091 kg
ACL LENS 55x280mm DA25°	28002209	doppelt asymmetrisch 25°	94 %	60 Stk.	0,072 kg
ACL LENS 55x280mm A20°	28002210	asymmetrisch 20°	93 %	60 Stk.	0,058 kg
ACL SHADE 55x280mm UGR	28002211	UGR verbessernd	-	60 Stk.	0,027 kg

1. Photometrische Eigenschaften

1.1 Lichtverteilung für ACL LENS 55x280mm 60°

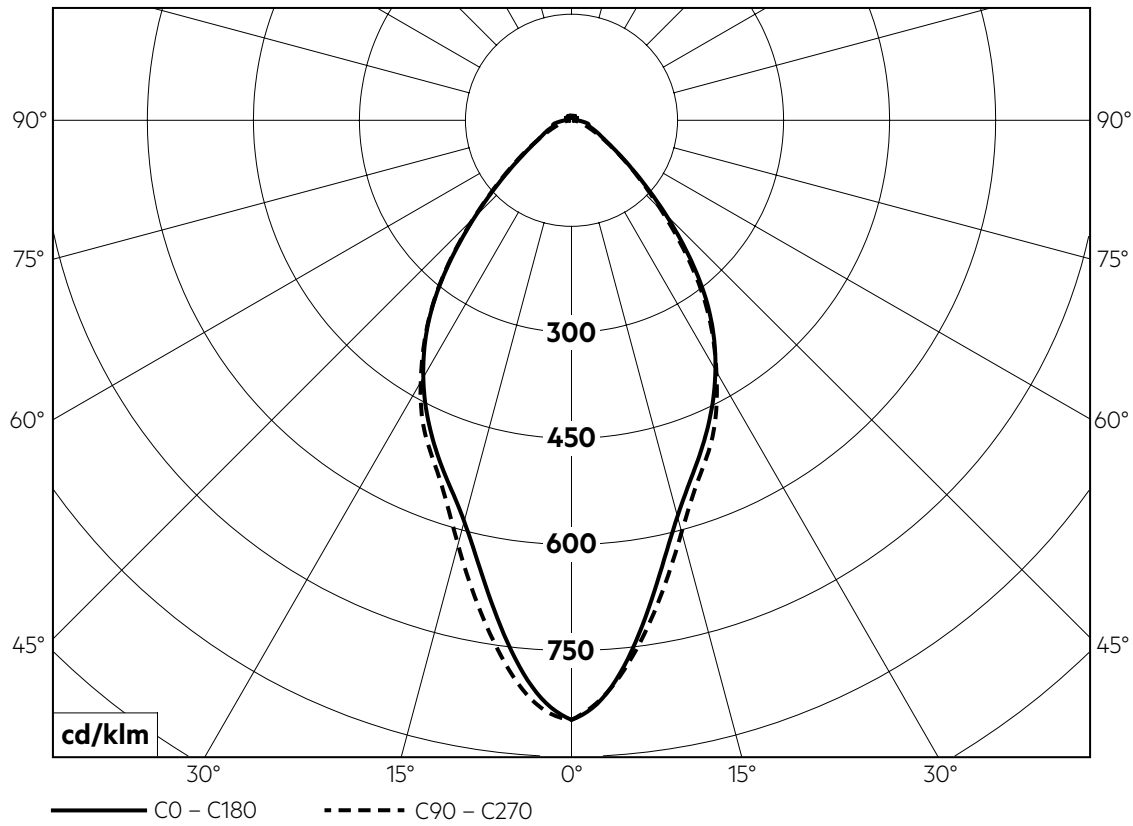

1.2 Lichtverteilung für ACL LENS 55x280mm 60° mit ACL SHADE

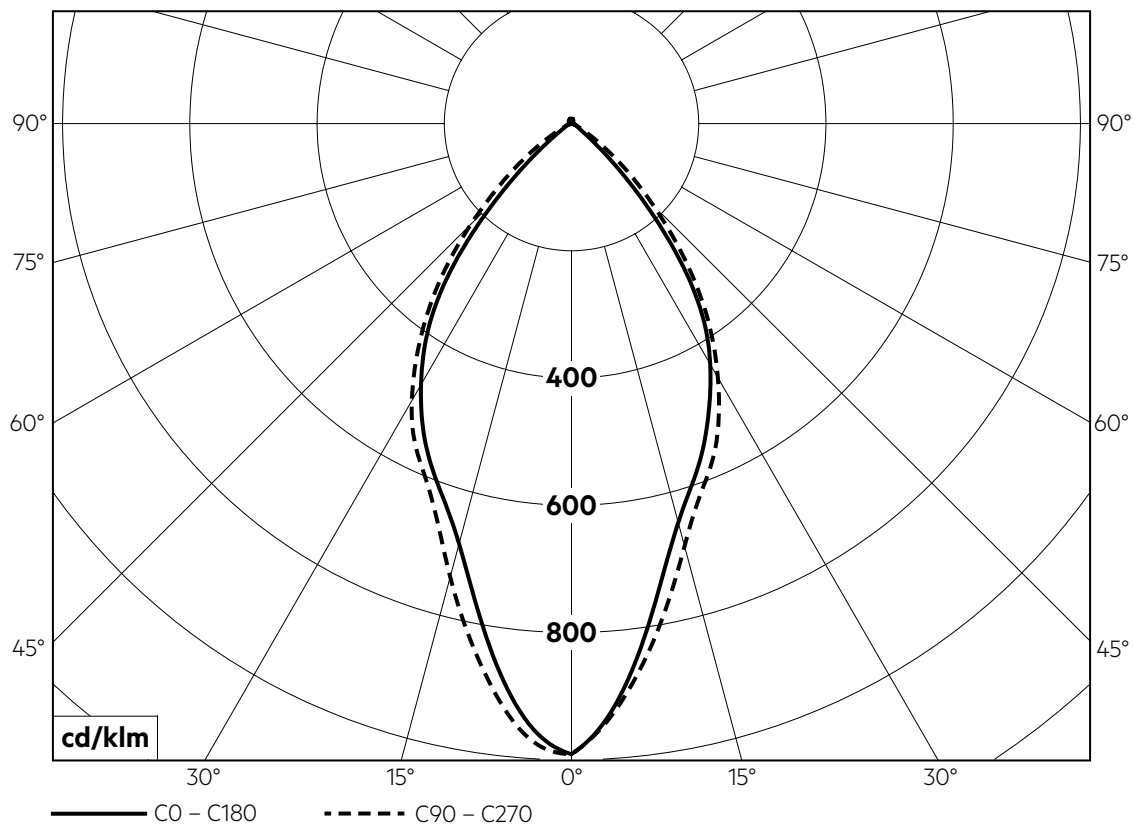

1.3 Lichtverteilung für ACL LENS 55x280mm 90°

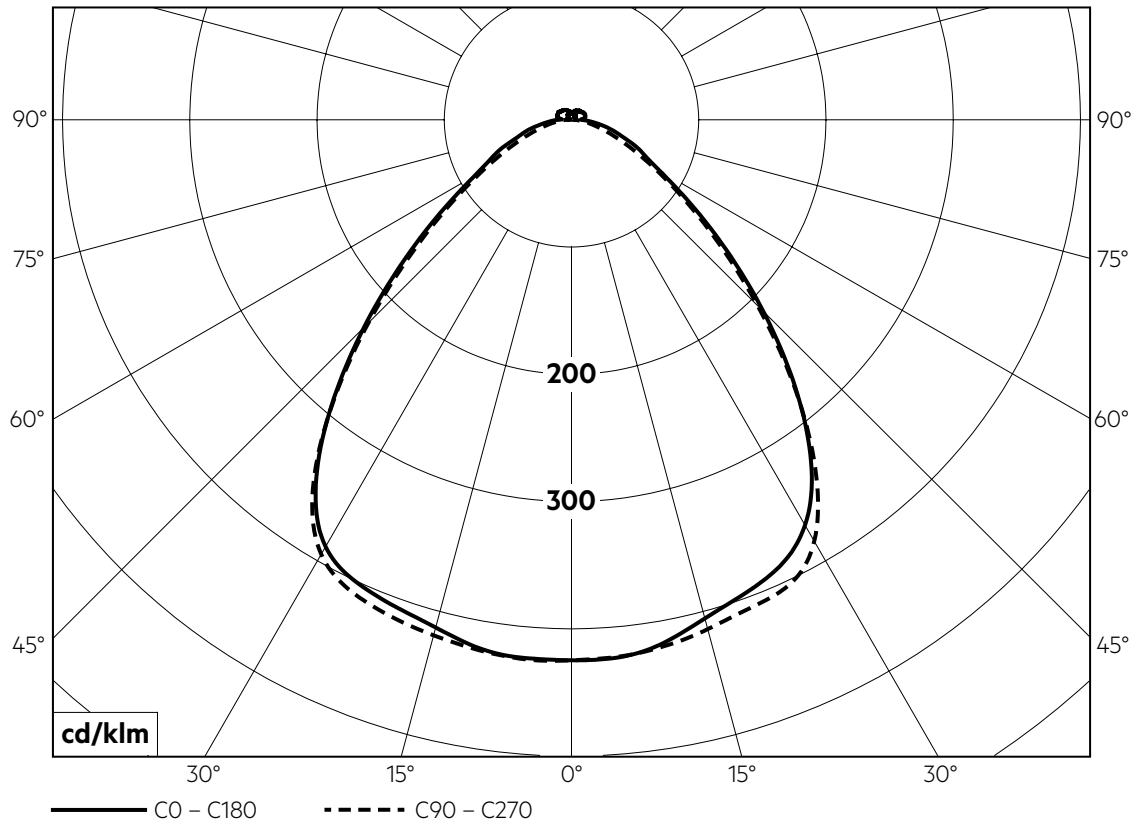

1.4 Lichtverteilung für ACL LENS 55x280mm 90° mit ACL SHADE

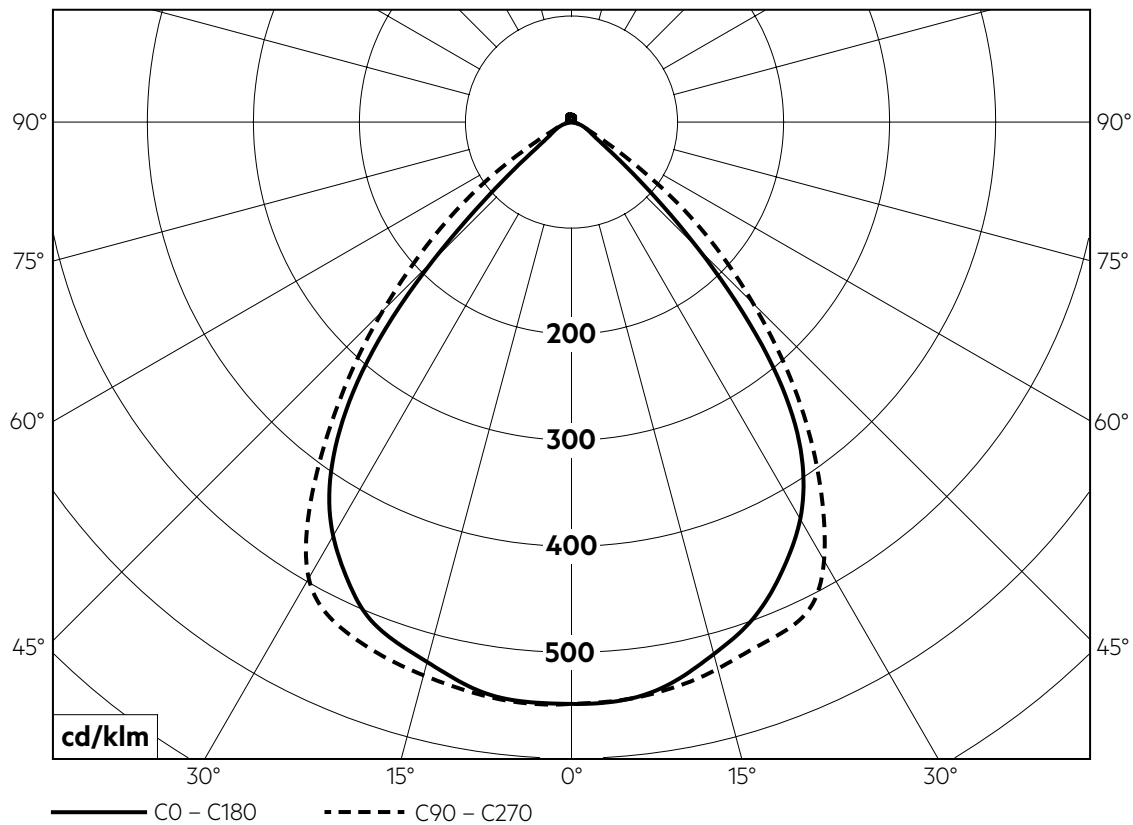

1.5 Lichtverteilung für ACL LENS 55x280mm 90x45°

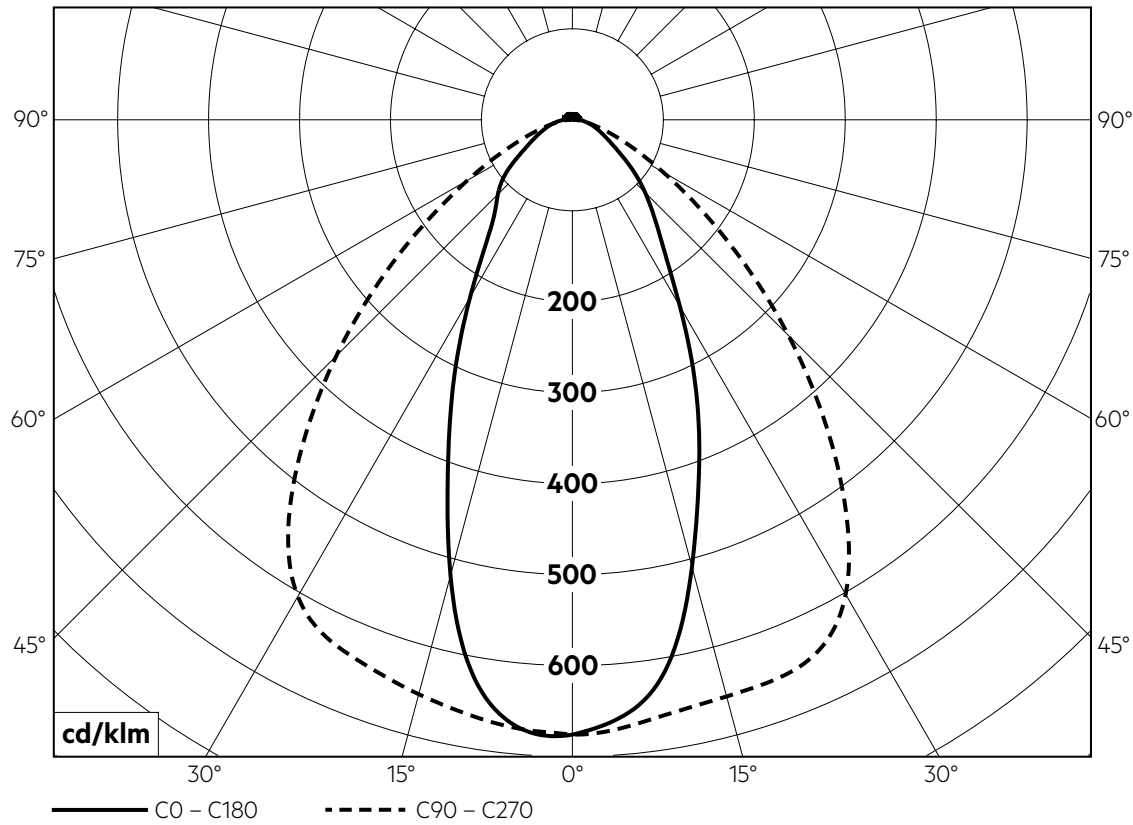

1.6 Lichtverteilung für ACL LENS 55x280mm 90x45° mit ACL SHADE

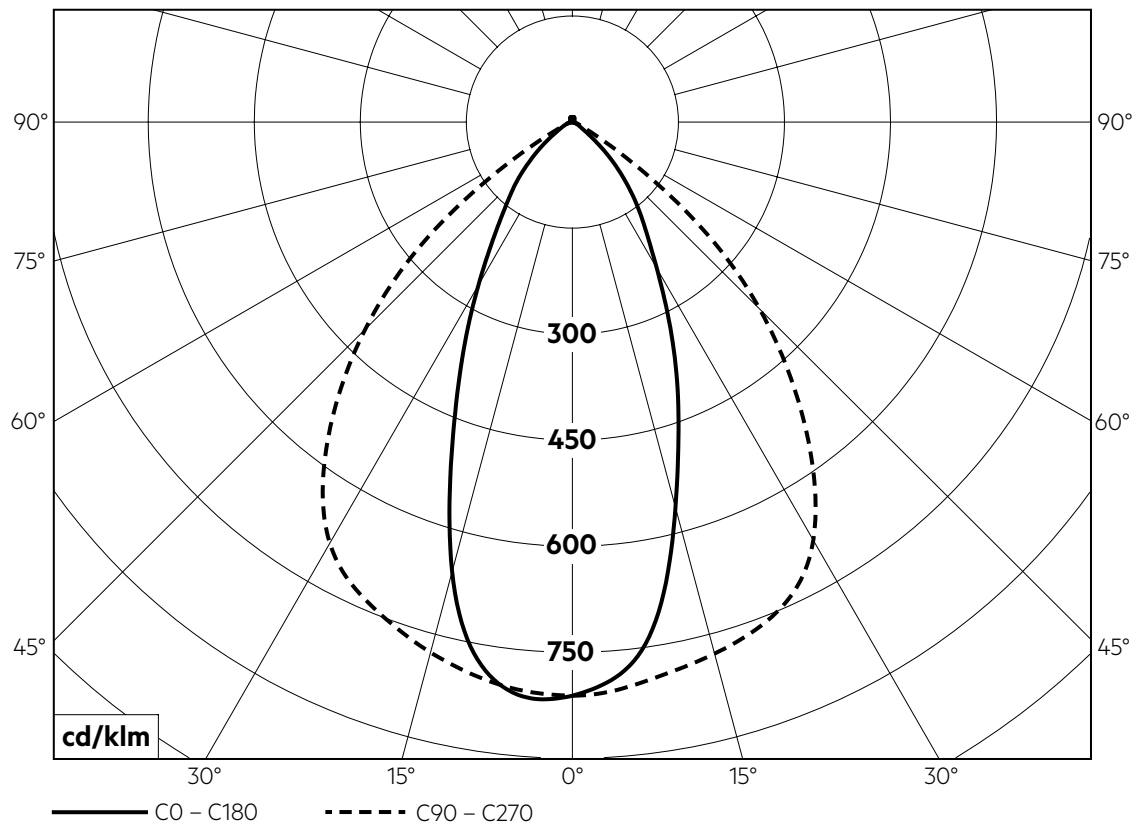

1.7 Lichtverteilung für ACL LENS 55x280mm DA 25°

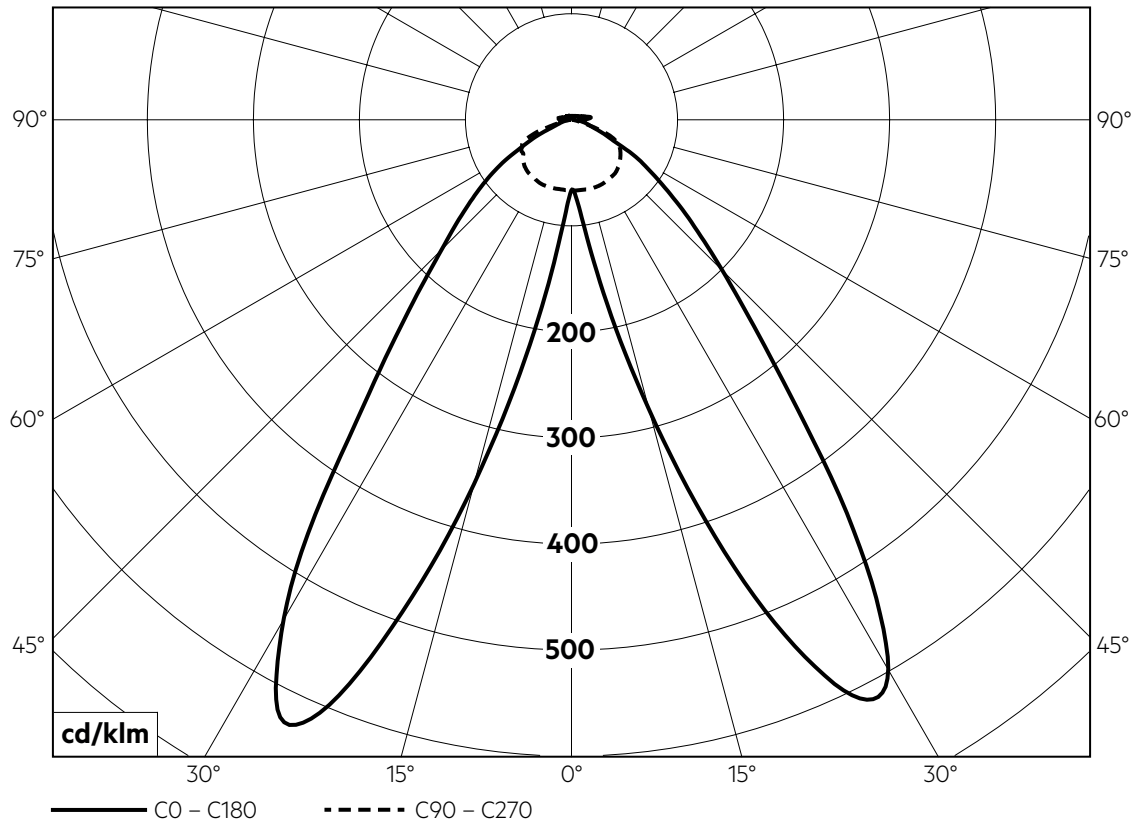

1.8 Lichtverteilung für ACL LENS 55x280mm A 20°

