

Electronic ballasts for dimming to 1 %
Linear lamps T5, 16 mm high efficiency, high output

PCA T5 ECO Ip x!tec 14–80 W 220–240 V 50/60/0 Hz

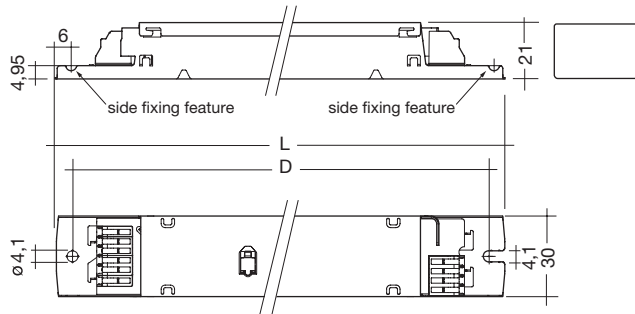

- world first: first processor-controlled ballast with x!tec inside
- operation of T5 lamps of the same length (e.g. FH 28 W / FQ 54 W)
- automatic lamp detection and operation with correct lamp parameters
- average service life = 50,000 h (at ta max. with a failure rate $\leq 0.2\%$ per 1,000 operating hours)
- dimming range from 1–100 %
- lamp friendly warm start within 0.5 s with AC and 0.2 s with DC
- power consumption in standby mode < 0.5 W
- disturbance free precise control with a digital DSI signal or switchDIM
- fully digital lamp management for flash-free starting at any dimming level

- operating frequency ~40–100 kHz
- integrated SMART interface
- Intelligent Voltage Guard (overvoltage indication and undervoltage protection)
- Intelligent Temperature Guard (overtemperature protection)
- automatically triggered emergency light value for DC and rectified AC voltage
- SMART Heating Concept for optimum filament heating at any dimming level and cut off the electrodes at approx. 90 % dimmlevel for maximum energy efficiency
- backwards compatibility adjustable
- corridorFUNCTION V2 with 3 profiles

Packaging:
360 mm housing
box of 10
76 boxes/pallet
760 pieces/pallet

425 mm housing
box of 25
33 boxes/pallet
825 pieces/pallet

Certified:
EN 55015
EN 55022
EN 60929
EN 61000-3-2
EN 61347-2-3
EN 61547
Suitable for emergency installations according to EN 50172

| Lamp | | Ballast | | | | | | | | | | |
|---------|------|--------------------------------|----------------|-------------|---------------------|-----------|-------------------|----------------|------------------------------|----------------------------|-------------|------------------------|
| wattage | type | type | article number | length L mm | fixing centres D mm | weight kg | circuit power W ② | lamp power W ② | current at 230 V / 50 Hz A ② | λ at 230 V / 50 Hz | tc point °C | temperature range °C ① |
| W | | | | | | | | | | | | |
| 1x14 | T5 | PCA 1x14/24 T5 ECO Ip x!tec | 22176247 | 360 | 350 | 0.25 | 16.0 | 1x14 | 0.08 | 0.95 | 80 | -25 → +60 |
| 2x14 | T5 | PCA 2x14/24 T5 ECO Ip x!tec | 22176248 | 360 | 350 | 0.28 | 32.5 | 2x14 | 0.15 | 0.97 | 80 | -25 → +60 |
| 1x24 | T5 | PCA 1x14/24 T5 ECO Ip x!tec | 22176247 | 360 | 350 | 0.25 | 25.5 | 1x24 | 0.12 | 0.97 | 80 | -25 → +60 |
| 1x24 | TC-L | PCA 1x14/24 T5 ECO Ip x!tec | 22176247 | 360 | 350 | 0.25 | 25.5 | 1x24 | 0.12 | 0.97 | 80 | -25 → +60 |
| 2x24 | T5 | PCA 2x14/24 T5 ECO Ip x!tec | 22176248 | 360 | 350 | 0.28 | 51.0 | 2x24 | 0.23 | 0.98 | 85 | -25 → +60 |
| 2x24 | TC-L | PCA 2x14/24 T5 ECO Ip x!tec | 22176248 | 360 | 350 | 0.28 | 51.0 | 2x24 | 0.23 | 0.98 | 85 | -25 → +60 |
| 1x21 | T5 | PCA 1x21/39 T5 ECO Ip x!tec | 22176245 | 360 | 350 | 0.25 | 23.5 | 1x21 | 0.11 | 0.95 | 85 | -25 → +60 |
| 2x21 | T5 | PCA 2x21/39 T5 ECO Ip x!tec | 22176246 | 425 | 415 | 0.35 | 45.5 | 2x21 | 0.21 | 0.97 | 80 | -25 → +60 |
| 1x39 | T5 | PCA 1x21/39 T5 ECO Ip x!tec | 22176245 | 360 | 350 | 0.25 | 42.0 | 1x39 | 0.20 | 0.97 | 85 | -25 → +60 |
| 1x40 | TC-L | PCA 1x21/39 T5 ECO Ip x!tec | 22176245 | 360 | 350 | 0.25 | 42.0 | 1x39 | 0.19 | 0.97 | 80 | -25 → +60 |
| 2x39 | T5 | PCA 2x21/39 T5 ECO Ip x!tec | 22176246 | 425 | 415 | 0.35 | 82.5 | 2x39 | 0.38 | 0.99 | 85 | -25 → +60 |
| 1x28 | T5 | PCA 1x28/54 T5 ECO Ip x!tec | 22176243 | 360 | 350 | 0.26 | 30.5 | 1x28 | 0.15 | 0.95 | 80 | -25 → +60 |
| 2x28 | T5 | PCA 2x28/54 T5 ECO Ip x!tec | 22176244 | 425 | 415 | 0.35 | 60.5 | 2x28 | 0.28 | 0.97 | 80 | -25 → +60 |
| 1x54 | T5 | PCA 1x28/54 T5 ECO Ip x!tec | 22176243 | 360 | 350 | 0.26 | 59.5 | 1x54 | 0.27 | 0.98 | 85 | -25 → +60 |
| 2x54 | T5 | PCA 2x28/54 T5 ECO Ip x!tec | 22176244 | 425 | 415 | 0.35 | 116.5 | 2x54 | 0.53 | 0.99 | 85 | -25 → +55 |
| 1x35 | T5 | PCA 1x35/49/80 T5 ECO Ip x!tec | 22176241 | 360 | 350 | 0.27 | 38.5 | 1x35 | 0.18 | 0.97 | 80 | -25 → +60 |
| 2x35 | T5 | PCA 2x35/49 T5 ECO Ip x!tec | 22176242 | 425 | 415 | 0.34 | 75.0 | 2x35 | 0.33 | 0.97 | 80 | -25 → +60 |
| 1x49 | T5 | PCA 1x35/49/80 T5 ECO Ip x!tec | 22176241 | 360 | 350 | 0.27 | 53.0 | 1x49 | 0.24 | 0.97 | 80 | -25 → +60 |
| 2x49 | T5 | PCA 2x35/49 T5 ECO Ip x!tec | 22176242 | 425 | 415 | 0.34 | 105.5 | 2x49 | 0.47 | 0.98 | 85 | -25 → +60 |
| 1x80 | T5 | PCA 1x35/49/80 T5 ECO Ip x!tec | 22176241 | 360 | 350 | 0.37 | 86.5 | 1x80 | 0.39 | 0.98 | 85 | -25 → +60 |
| 2x80 | T5 | PCA 2/80 T5 ECO Ip ③ | 22176054 | 425 | 415 | 0.35 | 164.5 | 2x80 | 0.75 | 0.99 | 80 | -25 → +50 |

① 10 °C to ta max: normal diming operation

-25 °C to +10 °C: dimming operation from 100 % to 30 %.

-25 °C to +10 °C, dimming below 30 %: Ballast could shut down but will not cause failure. This applies to AC and DC operation.

② valid at 100 % light output

③ single wattage ballast, corridorFUNCTION V1, power consumption in standby mode < 0.8 W

Lamp starting characteristics:

Warm start
Starting time 0.5 s with AC
Starting time 0.2 s with DC
Start at any dimming level

AC operation:

Mains voltage
220–240 V 50/60 Hz
198–264 V 50/60 Hz including safety
tolerance (±10 %)
202–254 V 50/60 Hz including performance
tolerance (+6 % / -8 %)

DC operation:

220–240 V 0 Hz
198–280 V 0 Hz certain lamp start
176–280 V 0 Hz operating range
Use in emergency lighting installations according to
EN 50172 or for emergency luminaires according
to EN 61347-2-3 appendix J.

Emergency units:

The “PCA T5 ECO Ip x:tec” ballasts are compatible
with all emergency units from TridonicAtco. See the
table in the data sheet. Also all “5-pole” emergency
units can be used. When used with other emergency
units tests are necessary.

Temperature range:

Unlimited dimming range from 10 °C to ta max.
-25 °C to +10 °C: dimming operation from 100 %
to 30 %. If dimm level goes below 30 % malfunction
possible, but no electronic ballast damage.
This applies to AC and DC operation.

Lamp type recognition:

Each of the lamps for which the control gear is designed
will be operated correctly according to the lamp
specifications. The currently used lamp is recognised
during the start up process.

To avoid an incorrect lamp recognition due to fast
multiple ON/OFF switches, new lamp data are only
restored if the lamp has operated for at least 5
seconds.

Mains currents in DC operation (at 70 % light output):

| wattage W | lamp type | Ballast type | Mains current at Un = 220 Vdc | Mains current at Un = 240 Vdc |
|--------------|--------------|--------------------------------|----------------------------------|----------------------------------|
| 1x14 | T5 | PCA 1x14/24 T5 ECO Ip x:tec | 0.06 A | 0.06 A |
| 2x14 | T5 | PCA 2x14/24 T5 ECO Ip x:tec | 0.12 A | 0.12 A |
| 1x24/1x14 | T5/TC-L | PCA 1x14/24 T5 ECO Ip x:tec | 0.10 A / 0.10 A | 0.09 A / 0.09 A |
| 2x24/2x24 | T5/TC-L | PCA 2x14/24 T5 ECO Ip x:tec | 0.20 A / 0.20 A | 0.18 A / 0.18 A |
| 1x21 | T5 | PCA 1x21/39 T5 ECO Ip x:tec | 0.09 A | 0.08 A |
| 2x21 | T5 | PCA 2x21/39 T5 ECO Ip x:tec | 0.17 A | 0.16 A |
| 1x39/1x40 | T5/TC-L | PCA 1x21/39 T5 ECO Ip x:tec | 0.15 A / 0.15 A | 0.14 A / 0.14 A |
| 2x39 | T5 | PCA 2x21/39 T5 ECO Ip x:tec | 0.30 A | 0.28 A |
| 1x28 | T5 | PCA 1x28/54 T5 ECO Ip x:tec | 0.11 A | 0.11 A |
| 2x28 | T5 | PCA 2x28/54 T5 ECO Ip x:tec | 0.21 A | 0.20 A |
| 1x54 | T5 | PCA 1x28/54 T5 ECO Ip x:tec | 0.21 A | 0.20 A |
| 2x54 | T5 | PCA 2x28/54 T5 ECO Ip x:tec | 0.42 A | 0.38 A |
| 1x35 | T5 | PCA 1x35/49/80 T5 ECO Ip x:tec | 0.14 A | 0.13 A |
| 2x35 | T5 | PCA 2x35/49 T5 ECO Ip x:tec | 0.26 A | 0.24 A |
| 1x49 | T5 | PCA 1x35/49/80 T5 ECO Ip x:tec | 0.18 A | 0.17 A |
| 2x49 | T5 | PCA 2x35/49 T5 ECO Ip x:tec | 0.36 A | 0.33 A |
| 1x80 | T5 | PCA 1x35/49/80 T5 ECO Ip x:tec | 0.30 A | 0.27 A |
| 2x80 | T5 | PCA 2/80 T5 ECO Ip | 0.79 A | 0.72 A |

Ballast lumen factor AC operation (AC-BLF) EN 60929 8.1:

| wattage W | lamp type | Ballast type | AC-BLF at Un = 230 VAC |
|--------------|--------------|--------------------------------|---------------------------|
| 1x14 | T5 | PCA 1x14/24 T5 ECO Ip x:tec | 1.00 |
| 2x14 | T5 | PCA 2x14/24 T5 ECO Ip x:tec | 0.99 |
| 1x24/1x14 | T5/TC-L | PCA 1x14/24 T5 ECO Ip x:tec | 1.01 / 1.04 |
| 2x24/2x24 | T5/TC-L | PCA 2x14/24 T5 ECO Ip x:tec | 1.02 / 1.02 |
| 1x21 | T5 | PCA 1x21/39 T5 ECO Ip x:tec | 1.03 |
| 2x21 | T5 | PCA 2x21/39 T5 ECO Ip x:tec | 1.02 |
| 1x39/1x40 | T5/TC-L | PCA 1x21/39 T5 ECO Ip x:tec | 1.02 / 0.97 |
| 2x39 | T5 | PCA 2x21/39 T5 ECO Ip x:tec | 1.02 |
| 1x28 | T5 | PCA 1x28/54 T5 ECO Ip x:tec | 1.00 |
| 2x28 | T5 | PCA 2x28/54 T5 ECO Ip x:tec | 1.01 |
| 1x54 | T5 | PCA 1x28/54 T5 ECO Ip x:tec | 1.00 |
| 2x54 | T5 | PCA 2x28/54 T5 ECO Ip x:tec | 1.01 |
| 1x35 | T5 | PCA 1x35/49/80 T5 ECO Ip x:tec | 0.99 |
| 2x35 | T5 | PCA 2x35/49 T5 ECO Ip x:tec | 0.98 |
| 1x49 | T5 | PCA 1x35/49/80 T5 ECO Ip x:tec | 1.02 |
| 2x49 | T5 | PCA 2x35/49 T5 ECO Ip x:tec | 1.00 |
| 1x80 | T5 | PCA 1x35/49/80 T5 ECO Ip x:tec | 1.02 |
| 2x80 | T5 | PCA 2/80 T5 ECO Ip | 1.00 |

The ballast lumen factor for AC operation (AC-BLF) does not alter from Un = 198 VAC to Un = 254 VAC.
The ballast lumen factor for DC operation (DC-BLF) on the basis of an automatic power reduction of the ballasts
(default value is 70 %) will be smaller than AC. It does not alter in the DC operating range (198–280 Vdc).

Harmonic distortion in the mains supply (at 230 V / 50 Hz):

| wattage W | lamp type | Ballast type | THD | 3 | 5 | 7 | 9 | 11 |
|--------------|--------------|--------------------------------|---------|---------|---------|---------|---------|---------|
| 1x14 | T5 | PCA 1x14/24 T5 ECO Ip x:tec | 10.2 | 5.4 | 6.1 | 3.2 | 2.2 | 1.6 |
| 2x14 | T5 | PCA 2x14/24 T5 ECO Ip x:tec | 7.8 | 4.3 | 2.5 | 2.5 | 2.7 | 2.2 |
| 1x24/1x14 | T5/TC-L | PCA 1x14/24 T5 ECO Ip x:tec | 6.1/6.9 | 4.6/5.8 | 1.1/1.1 | 1.2/1.4 | 1.2/1.2 | 1.2/1.3 |
| 2x24/2x24 | T5/TC-L | PCA 2x14/24 T5 ECO Ip x:tec | 4.8/8.5 | 3.2/6.2 | 1.4/1.8 | 2.0/2.7 | 1.3/1.9 | 1.2/1.7 |
| 1x21 | T5 | PCA 1x21/39 T5 ECO Ip x:tec | 8.1 | 5.9 | 2.4 | 2.5 | 2.5 | 1.6 |
| 2x21 | T5 | PCA 2x21/39 T5 ECO Ip x:tec | 7.2 | 3.6 | 4.4 | 2.5 | 1.5 | 1.5 |
| 1x39/1x40 | T5/TC-L | PCA 1x21/39 T5 ECO Ip x:tec | 7.0/6.2 | 5.5/4.7 | 1.1/0.7 | 2.1/1.4 | 1.5/1.0 | 1.3/0.9 |
| 2x39 | T5 | PCA 2x21/39 T5 ECO Ip x:tec | 5.3 | 4.0 | 2.5 | 1.8 | 0.6 | 0.9 |
| 1x28 | T5 | PCA 1x28/54 T5 ECO Ip x:tec | 9.74 | 3.93 | 3.39 | 2.68 | 2.52 | 2.44 |
| 2x28 | T5 | PCA 2x28/54 T5 ECO Ip x:tec | 10.0 | 7.3 | 1.7 | 2.1 | 2.2 | 1.9 |
| 1x54 | T5 | PCA 1x28/54 T5 ECO Ip x:tec | 5.6 | 3.5 | 1.5 | 1.6 | 1.1 | 1.3 |
| 2x54 | T5 | PCA 2x28/54 T5 ECO Ip x:tec | 8.9 | 8.5 | 1.4 | 1.5 | 0.7 | 0.7 |
| 1x35 | T5 | PCA 1x35/49/80 T5 ECO Ip x:tec | 9.1 | 6.0 | 4.2 | 2.2 | 1.9 | 1.8 |
| 2x35 | T5 | PCA 2x35/49 T5 ECO Ip x:tec | 8.7 | 7.2 | 1.4 | 1.4 | 1.4 | 0.9 |
| 1x49 | T5 | PCA 1x35/49/80 T5 ECO Ip x:tec | 9.6 | 7.8 | 4.3 | 1.8 | 1.0 | 1.0 |
| 2x49 | T5 | PCA 2x35/49 T5 ECO Ip x:tec | 7.8 | 7.5 | 0.6 | 1.1 | 0.6 | 0.7 |
| 1x80 | T5 | PCA 1x35/49/80 T5 ECO Ip x:tec | 8.1 | 7.8 | 1.6 | 0.6 | 0.5 | 0.6 |
| 2x80 | T5 | PCA 2/80 T5 ECO Ip | 6.8 | 5.4 | 4.1 | 0.8 | 0.8 | 0.7 |

Dimming:

Dimming curve is adapted to the eye sensitiveness.
Dimming range 1 % to 100 %
Digital control with DSI signal:
8 bit Manchester Code
Speed 1 % to 100 % in 1.4 s

Control input (D1, D2):

Digital DSI signal, push-to-make switch (switchDIM) or a motion detector (corridorFUNCTION) can be wired on the same terminals (D1 and D2).

Digital signal DSI:

The control input is non-polar and protected against accidental connection with a mains voltage up to 264 V. The control signal is not SELV. Control cable has to be installed in accordance to the requirements of low voltage installations.
Different functions depending on each module.

SMART interface:

An additional interface for the direct connection of the SMART-LS II Ip¹⁾ light sensor or corridorFUNCTION Plugs.

Application and functionality see corridorFUNCTION user manual.

SMART-LS II Ip¹⁾ light sensor operating mode:

The sensor registers actual ambient light and maintains the individually defined lux level.

After every mains reset the SMART interface automatically checks for an installed sensor. With the sensor installed the PCA T5 ECO Ip x:tec automatically runs in the constant lux level mode.

ON/OFF switch via mains, switchDIM or DSI signal.

DSI signal = 0 switches off,

DSI signal ≥ 1 switches on.

With switchDIM signals it is possible to change the controlled light level temporarily.

Temporarily means that after a switching cycle OFF/ON command the ballast will start at the preset value determined by the SMART-LS II Ip. The installation of the two wire bus is according to the appropriate low voltage regulations.

switchDIM:

Integrated switchDIM function allows a direct connection of a push to make switch for dimming and switching.

¹⁾ SMART-LS II Ip: article number 86458258

Dimming characteristics

PCA T5 ECO Ip x:tec

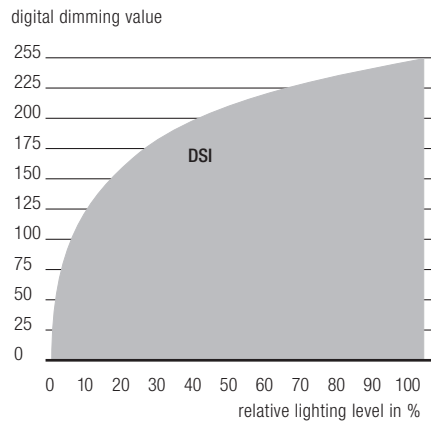

Dimming characteristics as seen by the human eye

Energy saving

PCA T5 ECO Ip x:tec

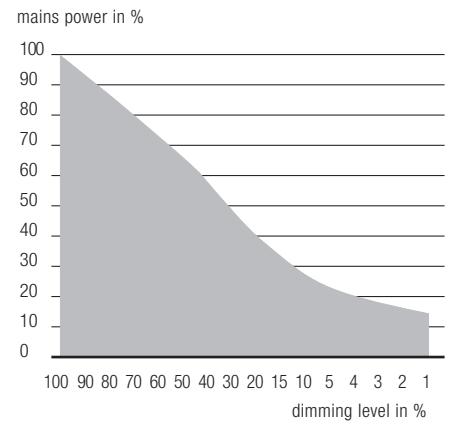

Brief push (< 0.6 s) switches ballast ON and OFF. The ballasts switch-ON at light level set at switch-OFF.

When the push to make switch is held, PCA ballasts are dimmed. After repush the PCA is dimmed in the opposite direction.

The switchDIM fade time is set to 3 s from min. to max. in the factory settings. With a 20 s push to the push to make switch this fade time can be changed to 6 s. In this instance the switchDIM application will be synchronized to 50 % light level after 10 s and after 20 s the light level rises to 100 % with the new fade time.

At every synchronisation (10 s keystroke) the device will reset to 3 s (factory setting)

In installations with PCAs with different dimming levels or opposite dimming directions (e.g. after a system extension), all PCAs can be synchronized to 50 % dimming level by a 10 s push.

Use of push to make switch with indicator lamp is not permitted.

Deactivation: If the corridorFUNCTION is wrongly activated in a switchDIM system (for example a switch is used instead of pushbutton), there is the option of installing a pushbutton and deactivating the corridorFUNCTION mode by five short pushes of the button within three seconds.

Backwards compatibility:

With a simple key combination a PCA T5 ECO Ip x:tec can be reset as a normal PCA ECO from the previous generation. Synchronisation simply has to take place three times within one minute (3 x 10 s).

To activate the "x:tec" settings again, synchronisation has to take place four times within one minute.

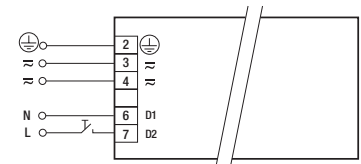

switchDIM PCA T5 ECO Ip x:tec

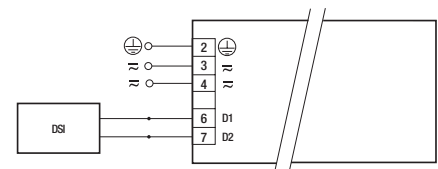

DSI PCA T5 ECO Ip x:tec

Dimmable ballasts from TridonicAtco have to be earthed.

Loading of automatic circuit breakers:

| Automatic circuit breaker type | C10 | C13 | C16 | C20 | B10 | B13 | B16 | B20 |
|--------------------------------|---------------------|---------------------|---------------------|---------------------|---------------------|---------------------|---------------------|---------------------|
| Installation Ø | 1.5 mm ² | 1.5 mm ² | 1.5 mm ² | 2.5 mm ² | 1.5 mm ² | 1.5 mm ² | 1.5 mm ² | 2.5 mm ² |
| PCA 1x14/24 T5 ECO Ip x:tec | 50 | 80 | 110 | 135 | 25 | 40 | 75 | 90 |
| PCA 2x14/24 T5 ECO Ip x:tec | 24 | 34 | 48 | 52 | 12 | 17 | 24 | 26 |
| PCA 1x21/39 T5 ECO Ip x:tec | 34 | 50 | 76 | 86 | 17 | 25 | 38 | 43 |
| PCA 2x21/39 T5 ECO Ip x:tec | 16 | 22 | 32 | 36 | 8 | 11 | 16 | 18 |
| PCA 1x28/54 T5 ECO Ip x:tec | 24 | 34 | 48 | 52 | 12 | 17 | 24 | 26 |
| PCA 2x28/54 T5 ECO Ip x:tec | 16 | 22 | 32 | 34 | 8 | 11 | 16 | 17 |
| PCA 1x35/49/80 T5 ECO Ip x:tec | 16 | 24 | 32 | 38 | 8 | 12 | 16 | 19 |
| PCA 2x35/49 T5 ECO Ip x:tec | 16 | 22 | 32 | 34 | 8 | 11 | 16 | 17 |
| PCA 2/80 T5 ECO Ip | 10 | 14 | 20 | 22 | 5 | 7 | 10 | 11 |

Continuous operation: to calculate the protective safety switch see main current, page 1



corridorFUNCTION

Activation: To activate the corridorFUNCTION a voltage of 230V simply has to be applied for five minutes at D1, D2. The unit will then switch automatically to the corridorFUNCTION.

Deactivation: If the corridorFUNCTION is wrongly activated in a switchDIM system (for example a switch is used instead of pushbutton), there is the option of installing a pushbutton and deactivating the corridorFUNCTION mode by five short pushes of the button within three seconds.

The corridorFUNCTION V2 offers the added benefit of a second and third preprogrammed profile, which can be activated by the corridorFUNCTION plugs.

Application and functionality of profiles see user manual.



Intelligent Temperature Guard

The intelligent temperature guard protects the PCA T5 ECO Ip x:tec from thermal overheating by reducing the output power or switching off in case of operation above the thermal limits of the luminaire or ballast. Depending on the luminaire design, the ITG operates at about 5 to 10 °C above Tc temperature.



Intelligent Voltage Guard

Intelligent Voltage Guard is the name of the new electronic monitor from TridonicAtco. This innovative feature of the PCA family of control gear from TridonicAtco immediately shows if the mains voltage rises above or falls below certain thresholds. Measures can then be taken quickly to prevent damage to the control gear.

- If the mains voltage rises above approx. 305 V (voltage depends on the ballast type), the lamp starts flashing on and off.
- This signal "demands" disconnection of the power supply to the lighting system.
- The active-current-control of these control gears is protected against failure caused by the high mains currents generated as a result of mains undervoltage. The switch off level depends on lamp wattage and is typically < 140 V.

Operating voltage:

| Wattage W | lamp type | Ballast type | U _{out} |
|-------------|-----------|--------------------------------|------------------|
| 1x14 | T5 | PCA 1x14/24 T5 ECO Ip x:tec | 400 V |
| 2x14 | T5 | PCA 2x14/24 T5 ECO Ip x:tec | 400 V |
| 1x24 / 1x14 | T5/TC-L | PCA 1x14/24 T5 ECO Ip x:tec | 400 V / 400 V |
| 2x24 / 2x24 | T5/TC-L | PCA 2x14/24 T5 ECO Ip x:tec | 400 V / 400 V |
| 1x21 | T5 | PCA 1x21/39 T5 ECO Ip x:tec | 400 V |
| 2x21 | T5 | PCA 2x21/39 T5 ECO Ip x:tec | 400 V |
| 1x39 / 1x40 | T5/TC-L | PCA 1x21/39 T5 ECO Ip x:tec | 400 V / 400 V |
| 2x39 | T5 | PCA 2x21/39 T5 ECO Ip x:tec | 400 V |
| 1x28 | T5 | PCA 1x28/54 T5 ECO Ip x:tec | 430 V |
| 2x28 | T5 | PCA 2x28/54 T5 ECO Ip x:tec | 430 V |
| 1x54 | T5 | PCA 1x28/54 T5 ECO Ip x:tec | 430 V |
| 2x54 | T5 | PCA 2x28/54 T5 ECO Ip x:tec | 430 V |
| 1x35 | T5 | PCA 1x35/49/80 T5 ECO Ip x:tec | 430 V |
| 2x35 | T5 | PCA 2x35/49 T5 ECO Ip x:tec | 430 V |
| 1x49 | T5 | PCA 1x35/49/80 T5 ECO Ip x:tec | 430 V |
| 2x49 | T5 | PCA 2x35/49 T5 ECO Ip x:tec | 430 V |
| 1x80 | T5 | PCA 1x35/49/80 T5 ECO Ip x:tec | 430 V |
| 2x80 | T5 | PCA 2/80 T5 ECO Ip | 430 V |

Installation instructions:

Wiring type and cross section:

The wiring can be solid cable with a cross section of 0.5 to 0.75 mm² for push terminal and 0.5 mm² for IDC terminal. For the push-wire connection you have to strip the insulation (8–9 mm).

wire preparation:
0.5 – 0.75 □

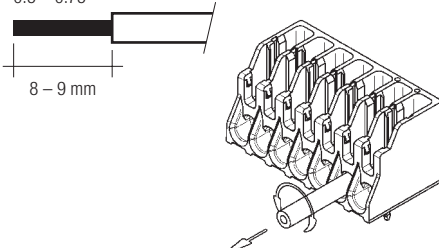

Loosen wire through twisting and pulling

Wiring advice:

The lead length is dependent on the capacitance of the cable.

| Ballast Type | Terminal | | Maximum capacitance allowed | |
|--------------------------|----------------|---------------|-----------------------------|--------|
| | Cold | Hot | Cold | Hot |
| PCA 1/xx T5 ECO Ip x:tec | 11, 12 | 9, 10 | 200 pF | 100 pF |
| PCA 2/xx T5 ECO Ip x:tec | 11, 12, 13, 14 | 9, 10, 15, 16 | 200 pF | 100 pF |

With standard solid wire 0.5/0.75 mm² the capacitance of the lead is 30–80 pF/m.

This value is influenced by the way the wiring is made.

Lamp connection should be made with symmetrical wiring.

Hot leads (9, 10, 15, 16) and cold leads (11, 12, 13, 14) should be separated as much as possible.

When using two or more dimmable ballasts in one luminaire with separate dimming controls, the lamp leads must be kept separate.

Dimmable ballasts from TridonicAtco have to be earthed.

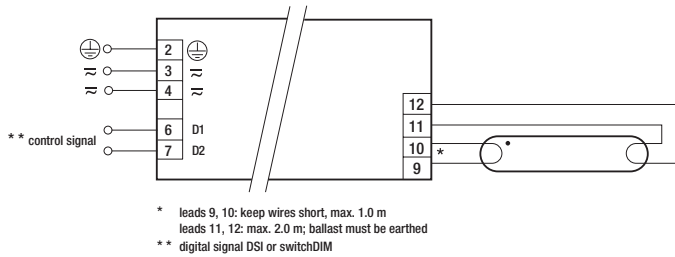

PCA T5 ECO Ip x:tec 1x14-80W

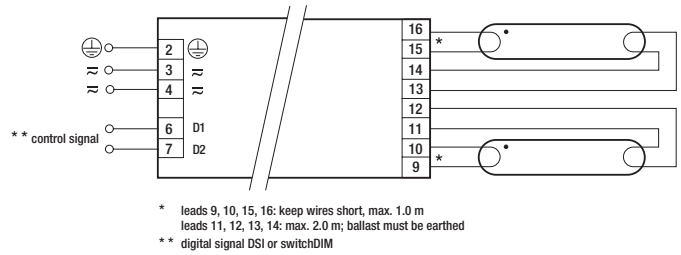

PCA T5 ECO Ip x:tec 2x14-49W

PCA T5 ECO Ip 2/80W

Dimmable ballasts from TridonicAtco have to be earthed.

RFI:

- Connection to the lamps of the hot leads must be kept as short as possible
- Mains leads should be kept apart from lamp leads (ideally 5–10 cm distance)
- Do not run mains leads adjacent to the electronic ballast
- Twist the lamp leads
- Keep the distance of lamp leads from the metal work as large as possible
- Mains wiring to be twisted when through wiring
- Keep the mains leads inside the luminaire as short as possible

General advise:

Electronic ballasts are virtually noise free. Magnetic fields generated during the ignition cycle can cause some background noise but only for a few milliseconds.

Operation on DC voltage:

Our ballasts are construed to operate DC voltage and pulsed DC voltage. To operate ballasts with pulsed DC voltage the polarity is absolute mandatory.

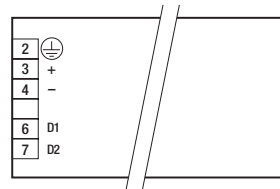

Isolation and electric strength testing of luminaires:

Electronic devices can be damaged by high voltage. This has to be considered during the routine testing of the luminaires in production.

According to IEC 60598-1 Annex Q (informative only!) or ENEC 303-Annex A, each luminaire should be submitted to an isolation test with 500 V DC for 1 second. This test voltage should be connected between the interconnected phase and neutral terminals and the earth terminal.

The isolation resistance must be at least 2 MΩ.

As an alternative, IEC 60598-1 Annex Q describes a test of the electrical strength with 1500 V AC (or 1.414 x 1500 V DC). To avoid damage to the electronic devices this test must not be conducted.

① For further technical information please visit www.tridonicatco.com