



DSI-SMART PTM

Ambient light sensor and motion detector for constant light control

Product description

- Ambient light sensor with motion detector
- Switch input for on/off switching and dimming
- 3 different casing versions
- For 4 (luminaire installation and surface mounting version) or 25 (ceiling installation version) DSI or DALI devices
- Functions can be configured with the DSI-SMART programmer
- 5-year guarantee

Technical data

Rated supply voltage	220 – 240 V
Mains frequency	50 / 60 Hz
Operating temperature	0 ... +60 °C
Storage temperature	-25 ... +60 °C
Type of protection	IP20



Wiring diagrams and installation examples, page 3

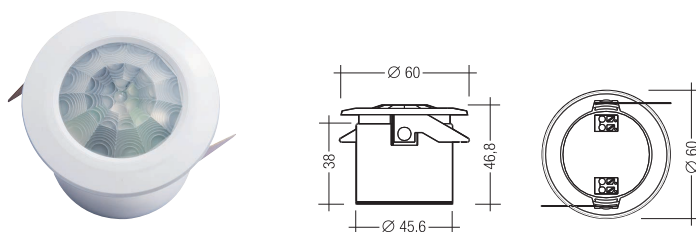

Fig. 1

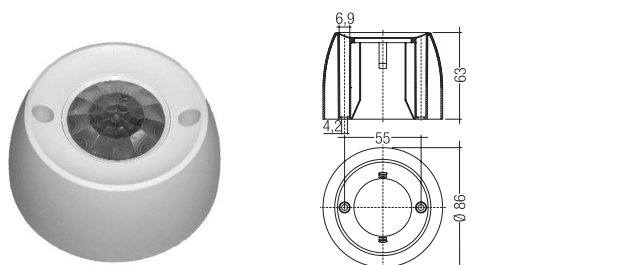

Fig. 2

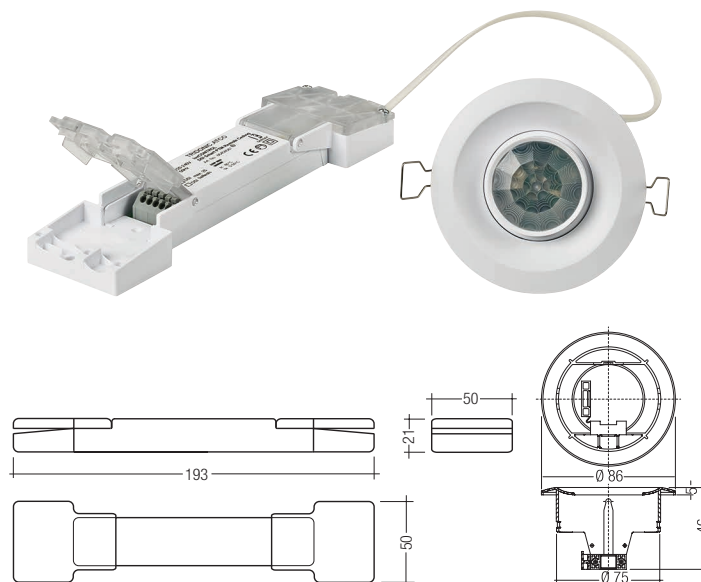

Fig. 3

Ordering data

Fig.	Mounting	Type	Article number	Packaging carton	Weight per pc.
1	Luminaire installation	DSI-SMART PTM integrated	28000878	10 pc(s).	0.064 kg
2	Surface mounting	DSI-SMART PTM remote surface	28000940	20 pc(s).	0.064 kg
3	Ceiling installation	DSI-SMART PTM remote ceiling	28000877	10 pc(s).	0.064 kg

Specific technical data

Type	Supply		Detection	Inputs	Outputs		
	Power	Output, standby	Light measurement at the sensor head ^①	Dimming switch	Digital control line DSI/DALI ^②	Control output per physical output (devices)	Maximum DSI cable length at 1.5 mm ²
DSI-SMART PTM integrated	1.7 W	1.5 W	5 – 500 lx	single	1	4	250 m
DSI-SMART PTM remote surface	1.7 W	1.5 W	5 – 500 lx	single	1	4	250 m
DSI-SMART PTM remote ceiling	3.9 W	1.3 W	5 – 500 lx	single	1	25	250 m

^① The measured value at the sensor head corresponds to approx. 10 to 1,500 lux on the surface measured.

^② DALI from DSI SMART PTM V1.1
For parameterization the DSI SMART Programmer from V2.01 is required.

**ACCES-
SORIES**

REMOTECONTROL IR6

Product description

- Optional infra-red remote control
- Switching on and off (On/Off button)
- Dimming (Up/Down button)
- Activation of automatic lighting control
- Setting the threshold control point (Set button)

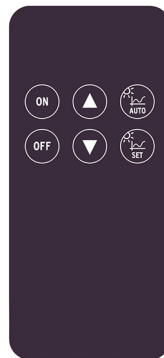

Ordering data

Type	Article number	Dimensions L x W x H	Packaging carton
REMOTECONTROL IR6	28000647	86.5 x 40.5 x 7.2 mm	500 pc(s).

**ACCES-
SORIES**

DSI SMART Programmer

Product description

- Optional infra-red programming unit for DSI-SMART PTM
- Settings can be read and modified
- Programmable functions such as light level, time delay, P.I.R., bright-out, power up, start, override
- 5-year guarantee

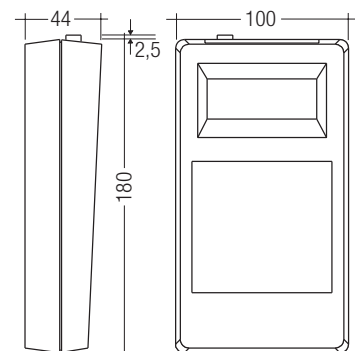

Ordering data

Type	Article number	Packaging carton	Weight per pc.
DSI-SMART Programmer	28000843	16 pc(s).	0.35 kg

1. Standards

EN 55015
EN 60669-2-1
EN 61000-3-2
EN 61000-3-3
EN 61347-2-11
EN 61547
EN 62386-101

1.1 DALI standard

DSI-SMART PTM is designed to control control gear with DALI standard IEC 60929 (DALI V0).

1.2 Glow-wire test

according to EN 60598-1 passed.

2. Interfaces / communication

2.1 Switch

DSI-SMART PTM has an input terminal for an external switch. Any number of switches can be connected in parallel to the terminal.

Short press (> 50–600 ms):	ON/OFF
Long press (> 600 ms):	Dim up/down A change in the light value deactivates lighting regulation only temporarily. As soon as the luminaire has been automatically switched on again (motion detection) or manually switched off and on again, regulation is activated again.
2 x short press:	The overwritten setpoint light value is stored (luminaire acknowledges by flashing twice) Function is lockable via the DSI programmer. ①

2.2 DSI/DALI interface

The interface selection DSI or DALI is made by the DSI SMART Programmer. ①

① From DSI SMART PTM V1.1

For parameterization the DSI SMART Programmer from V2.01 is required.

3. Installation

- DSI/DALI is not SELV. The installation instructions for mains voltage therefore apply.
- The maximum cable length between the external switch and DSI-SMART PTM is 100 m.
- The cable between the ceiling sensor and the base module must not be extended.
- A synchronous operation of DALI and DSI ballasts at the same control gear is not possible.
- The maximum cable length of the DSI/DALI control signal (for a cable cross-section of 1,5 m²) must not be exceeded.
- Any number of push to make switches may be connected in parallel to the inputs.
- Do not connect standard switches to the input.

3.1 Wiring diagram for DSI-SMART PTM (luminaire installation and surface-mounted boxes)

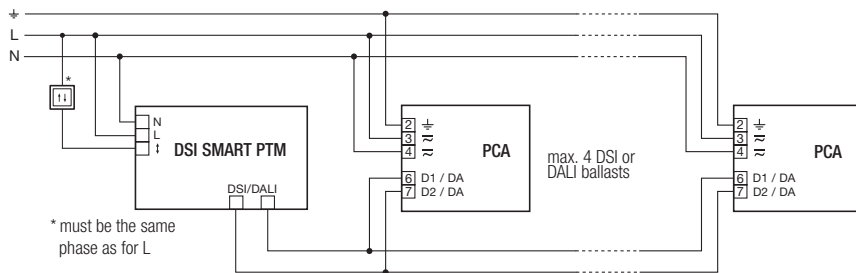

3.2 Wiring diagram for DSI-SMART PTM (ceiling installation box)

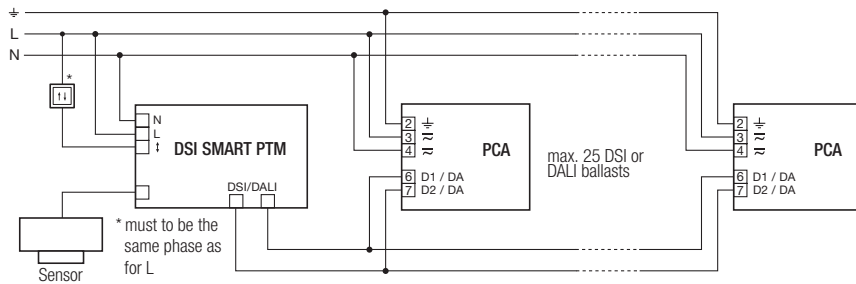

3.3 Cable types and cable cross-sections

Solid wire with a cable cross-section of 0,5 mm² to 1,5 mm².

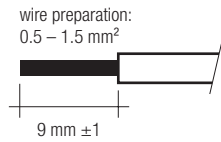

3.4 Mounting variants

Luminaire installation box:

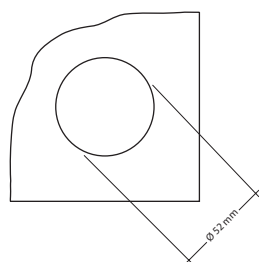

Ceiling installation box:

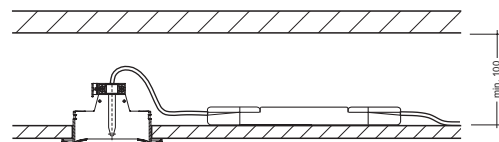
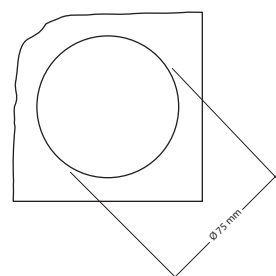

4. Sensor functions

4.1 Motion detector

Motion detection

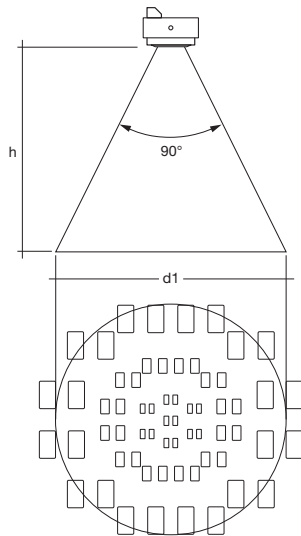

h * m	d1 m	d2 m
1.7	3.4	1.6
2.0	4.0	1.9
2.3	4.6	2.2
2.5	5.0	2.3
2.7	5.4	2.5
3.0	6.0	2.8
3.5	7.0	3.3
4.0	8.0	3.7

* The recommended maximum room height is 4 m.

Calculation of the diameter:
 $d = 2 \times \tan(0,5 \times \alpha) \times h$

The following operating modes can be set for the motion detector via the DSI-Smart Programmer:

Active	The light is switched on or off automatically depending on whether or not there is a person in the room.
Off Only	The motion detector only switches the connected lighting off. The luminaires are switched on manually via the connected external switch or infra-red control. If the „sec level„ is active, the lights will not be switched on although a motion is detected.
Never Off	If it has not detected any movement the sensor dims to the “second light value” parameter and remains at this value
Inactive	The motion sensor is deactivated. The light must be switched on or off manually.

4.2 Switch-off delay

This is the time after which the lighting is switched off if no movement is detected. It can be set via the “time delay” parameter.

4.3 Second light value

On the DSI-Smart PTM you can set whether the light is to be switched off after the switch-off delay or dimmed to the second light value. The light value and the dwell time (how long the value is held) can be set via the “when vacant” and “sec. level” parameters.

4.4 Manual-off delay

If the system is switched off manually via the switch or remote control the motion sensor is deactivated. At the end of a 10 minutes delay if motion has not been detected the motion sensor is activated again. If the sensor detects motion during the “Manual Off” delay, the time will be reset to the start.

4.5 Ambient light control

Light level recognition area

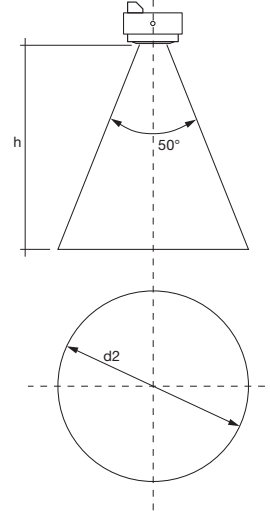

The following operating modes can be set for lighting control via the DSI-Smart Programmer:

Active	Constant light control is active.
Inactive	Constant light control is deactivated. The lighting is switched on at 100%.

The value is set with the “light-level” parameter. If the value is set to “max” then lighting control is deactivated. For all other values lighting control is active.

4.6 Setpoint adjustment

- DSI-SMART Controller: Pressing the Set button stores the current light value as a new setpoint.
- DSI-SMART Programmer: Via the “light-level” parameter
- External switch: Briefly pressing the switch twice stores the current light value as a new setpoint. (Function is lockable via the DSI programmer)

4.7 Bright-out

If the nominal illuminance (e.g. 500 lux) is exceeded for 10 minutes by more than 150% (e.g. 750 lux), the lighting is switched off even if motion is detected. The lighting is switched on again when the measured light value falls below the setpoint.

The bright-out function is displayed by a green status indication LED at the sensor.

This function can be deactivated via the DSI-SMART Programmer.

4.8 User-definable parameters

DSI-SMART PTM have the following user-definable parameters:
The values shown in bold are the factory default settings.

Parameter	Range Factory setting	Description
light-level	1-100/max/man 70	Light level in steps from 1 to 100. The "max" option lets you set the units at maximum output. (DSI 255) "man" indicates whether the control value has been overwritten with the SET functions of the SMART controller.
time delay	30 s-60 min/con 20	Delay before switching off after the last detection of movement. The options are as follows: 30 seconds, 1, 2, 3, 5, 10, 15, 20, 30, 45 and 60 minutes, and "con" (continuous)
when vacant	off 30 s-60 min/con	The "off" setting causes the luminaire to switch off at the end of the switch-off delay. The "low" setting causes the luminaire to fade to the "sec. Level" parameter and switch off only at the end of the "second" delay set. The options are as follows: off, 30 seconds, 1, 2, 3, 5, 10, 15, 20, 30, 45 and 60 minutes, and continuous ("never OFF" function)
sec. level	1-100 1	Second light value to which the system fades at the end of the switch-off delay. (In connection with the "when vacant" parameter)
P.I.R	active inactive off only	The "active" setting switches the light on or off automatically depending on whether or not there is someone in the room. With the "inactive" setting the DSI-SMART, in combination with "time delay continuous", can be used only for controlling the light level. In the "off only" setting the light has to be switched on manually (switch, remote control) but is switched off by the motion sensor.
bright-out	yes No	The "yes" setting switches the light off as soon as the light value exceeds 150% of the control value for more than 10 minutes. If the actual value falls below 100% the light is switched on again. In the "no" setting the luminaires remain at the minimum light value.
Power up	on off	In the "on" setting the luminaire switches on after a power outage. In the "off" setting the luminaire does not switch on after a power outage. After 15 seconds the motion sensor is active again.
hold overwrite	on off	In the "off" setting the DSI-SMART is reset to automatic mode when the control value is overwritten with the SMART controller or with the switch after an on/off cycle initiated by a movement interruption (end of delay time). If "on" is selected the luminaire switches on again with the overwritten value (manual light value) unless the overwritten value was an OFF command, in which case DSI-SMART returns to automatic mode so people do not enter a dark room.
PTM Set ①	on off	In the „on" setting the possibility to store of the lighting control value is activated by 2 short keypresses, in the „off" setting it is locked.
DALI or DSI ①	DSI DALI	Preselection of the type of interfaces DSI oder DALI

① From DSI SMART PTM V1.1

For parameterization the DSI SMART Programmer from V2.01 is required.

Parameter	Description
1	light - level time - delay
2	sec. level when vacant

see
parameterlist

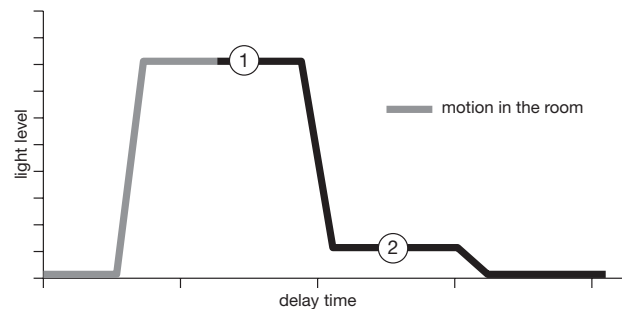

5. Miscellaneous

5.1 Additional information

Additional technical information at www.tridonic.com → Technical Data

Guarantee conditions at www.tridonic.com → Services

Life-time declarations are informative and represent no warranty claim.
No warranty if device was opened.