

## DALI TOUCHPANEL BASIC

Operating and control unit

### Product description

- Capacitive Touchpanel
- High-quality appearance with real glass display
- Multiple control modules are possible in a DALI system
- Power supply via DALI line
- Double terminals for through wiring
- Adjustment of DALI lighting group with "Group" rotary switch
- Individual adjustment of start number of lighting scenes with "Scene" rotary switch
- 5 years guarantee (conditions at [www.tridonic.com](http://www.tridonic.com))

Type TW:

- Tunable white (colour converter) control (colour temperature along the Planckian Locus, Colour temperature  $T_C$ )



**Wiring diagrams and installation examples**, page 6



DALI TOUCHPANEL BASIC C

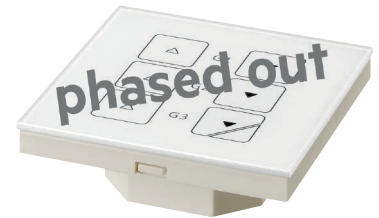

DALI TOUCHPANEL BASIC G

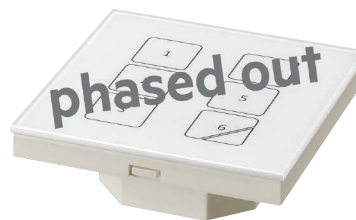

DALI TOUCHPANEL BASIC S



DALI TOUCHPANEL BASIC TW



### DALI TOUCHPANEL BASIC

Operating and control unit

#### Technical data

Supply via	DALI cable
Supply voltage <sup>①</sup>	9.5 – 22.5 V
Current draw	10 mA
Interface	DALI
Ambient temperature $t_a$	0 ... +50 °C
Max. casing temperature $t_c$	60 °C
Storage temperature $t_s$	0 ... +50 °C
Humidity	5 % ... max. 85 % (non-condensing)
Type of protection	IP20
Casing material	PC
Casing colour	RAL 9010 (white)
Mounting	in concealed box: $\varnothing 60 \times 61$ mm ( $\varnothing \times H$ )
Dimensions (L x W x H)	86 x 86 x 29.1 mm

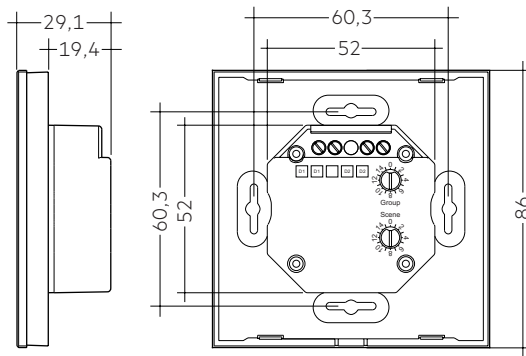

#### Ordering data

Type	Article number	Model	Packaging, carton	Weight per pc.
<b>DALI TOUCHPANEL BASIC C</b>	<b>28001987</b>	Combination	10 pc(s).	0.21 kg
<b>DALI TOUCHPANEL BASIC G</b>	<b>28001988</b>	Group	10 pc(s).	0.21 kg
<b>DALI TOUCHPANEL BASIC S</b>	<b>28001989</b>	Scene	10 pc(s).	0.21 kg
<b>DALI TOUCHPANEL BASIC TW</b>	<b>28001990</b>	Tunable White	10 pc(s).	0.21 kg

<sup>①</sup> Uin acc. IEC 62386-101.

**1. Standards**

EN 55015  
 EN 61347-1  
 EN 61347-2-11  
 EN 61547

**1.1 DALI standard**

DALI TOUCHPANEL BASIC is designed to control control gear with DALI standard IEC 60929 (DALI VO) and IEC 62386 (DALI V1).

**2. Settings**

The DALI TOUCHPANEL BASIC Models Combination, Group, Scene and Tunable White are multi-functional devices for DALI circuits. Every model offers 6 touch sensitive fields with unique functionalities to control your light. An additional position LED allows easy location of the DALI TOUCHPANEL BASIC in dark areas.

The combination of different rotary selector switches combined with the variety of 4 DALI TOUCHPANEL BASIC models offers an easy way to reach a high degree of flexibility without the need of additional programming. The easy configuration options are also efficient for easy replacement because only the rotary selector switch position has to be copied and no need of additional programming.

**2.1 Scene / Group switch**

Depending on the model one or two rotary selector switches are available. As a function from the position of the rotary switch different Scene or Group commands can be send to your DALI installation.

**Rotary selector switch Scenes**

Position	Recall Scene
0	0
1	1
2	2
3	3
4	4
5	5
6	6
7	7
8	8
9	9
10	10
11	11
12	12
13	13
14	14
15	15

**Rotary selector switch Group**

Position	DALI Group
0	Broadcast
1	0
2	1
3	2
4	3
5	4
6	5
7	6
8	7
9	8
10	9
11	10
12	11
13	12
14	13
15	14

**2.2 Rotary selector switch**

The rotary selector switch has 16 positions. Default setting is position 0 as illustrated in the picture below.

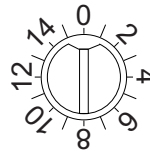

**2.3 Short / long press**

When in this documentation an short press is mentioned it means that the time of contact with the touch panel field was under 500 ms. Every contact longer than 500 ms will be recognized as a long press and will depending on the model send a different command than the short press.

Short press < 500 ms < long press

**2.4 Quick start guide**

If you do experience any issues with your installation make sure to follow the following quick start guide.

**Step 1:**

Make sure drivers connected to the DALI line are addressed, grouped and Scene values are saved as preferred.

Info: In case other Tridonic lighting components are used the commissioning of the DALI line can easy be achieved by using the Tridonic Software masterCONFIGURATOR in combination with the DALI USB via a Windows PC. But it can also be done by using other standard DALI commissioning tools of different manufacturers.

**Step 2:**

Program your TOUCHPANEL according to your needs. The programming is done via the rotary selector switches on the back of the panel. The exact functionality for every model is explained separate in the following chapters.

**Step 3:**

Mechanically install and wire your TOUCHPANEL as described in the chapter wiring. DALI is not SELV so the roles for mains voltage installation have to be applied!

**Step 4:**

Once all components are configured and installed make a test of your installation to get sure everything works as programmed.

If you have issues with your installation please check out our DALI quick start guide which can be found on our webpage [www.tridonic.com](http://www.tridonic.com) there you will find more information about DALI, how to commission a DALI line and troubleshooting help.

### 3. Interfaces / communication

#### 3.1 DALI TOUCHPANEL BASIC C

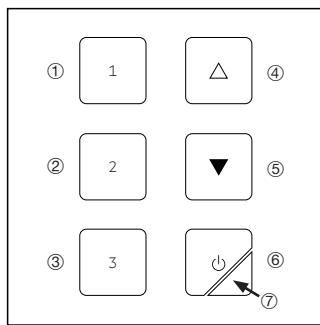

Front view

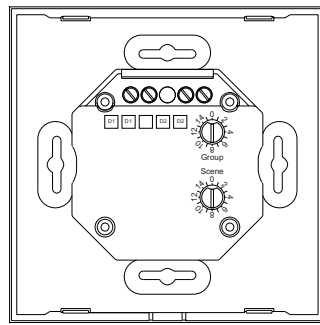

Back view

DALI TOUCHPANEL BASIC Combination offers two rotary selector switches the Group rotary selector switch allowing to select if a Group 0–14 or the whole DALI line via Broadcast should be controlled.

The Scene rotary selector switch allows to recall 3 Scene values 0–15.

Default position of the rotary selector switches Group and Scene is 0 in this position Scene 0, 1 and 2 will be recalled and all commands will be send via Broadcast to the whole DALI line.

- ① Broadcast go to Scene 0
- ② Broadcast go to Scene 1
- ③ Broadcast go to Scene 2
- ④ Broadcast dim up
- ⑤ Broadcast dim down
- ⑥ Broadcast toggle between recall max/OFF
- ⑦ Position LED activate/deactivate with long press default activated

If the rotary selector switch Scene is in position 14 then Scenes 14, 15 and 0 can be recalled and if the rotary selector switch Group is in position 2 then all commands will be send to Group 1. No other Group will react to the send commands.

- ① Group 1 go to Scene 14
- ② Group 1 go to Scene 15
- ③ Group 1 go to Scene 0
- ④ Group 1 dim up
- ⑤ Group 1 dim down
- ⑥ Group 1 toggle between recall max/OFF
- ⑦ Position LED activate/deactivate with long press default activated

#### 3.2 DALI TOUCHPANEL BASIC G

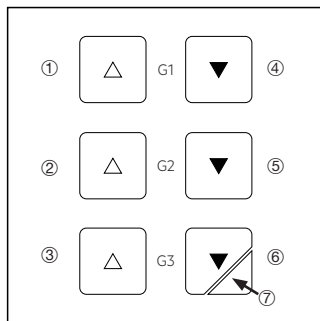

Front view

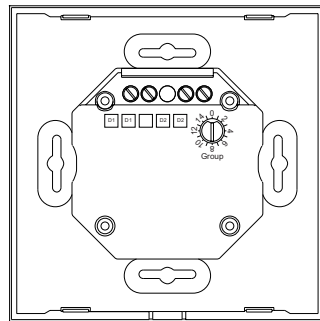

Back view

DALI TOUCHPANEL BASIC Group can control up to 3 DALI Groups.

Which Groups should be controlled can be selected with the Group rotary selector switch on the back.

Default position of the rotary selector switch Group is 0 in this position the whole DALI line can be controlled via Broadcast and in addition Group 0 and 1 can be controlled separately.

- ① Short press Broadcast recall max  
Long press Broadcast dim up
- ④ Short press Broadcast off  
Long press Broadcast dim down
- ② Short press Group 0 recall max  
Long press Group 0 dim up
- ⑤ Short press Group 0 off  
Long press Group 0 dim down
- ③ Short press Group 1 recall max  
Long press Group 1 dim up
- ⑥ Short press Group 1 off  
Long press Group 1 dim down
- ⑦ Position LED activate/deactivate with long press default activated

If the Group rotary selector switch is in position 14 then Groups 13, 14 and the whole DALI line Broadcast can be controlled.

- ① Short press Group 13 recall max  
Long press Group 13 dim up
- ④ Short press Group 13 off  
Long press Group 13 dim down
- ② Short press Group 14 recall max  
Long press Group 14 dim up
- ⑤ Short press Group 14 off  
Long press Group 14 dim down
- ③ Short press Broadcast recall max  
Long press Broadcast dim up
- ⑥ Short press Broadcast off  
Long press Broadcast dim down
- ⑦ Position LED activate/deactivate with long press default activated

3.3 DALI TOUCHPANEL BASIC S

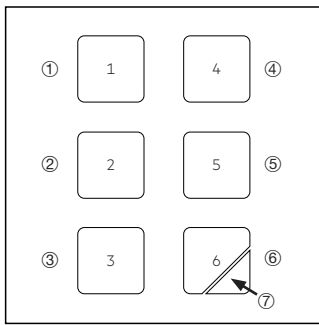

Front view

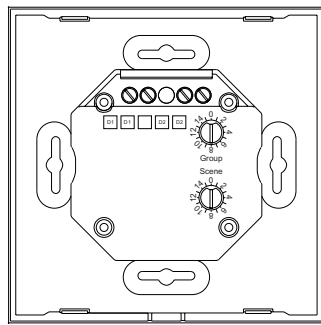

Back view

DALI TOUCHPANEL BASIC Scene offers two rotary selector switches on the back. The Scene rotary selector switch allows to select which Scenes should be recalled and the Group rotary selector switch allows to control for which Group the Scenes should be recalled.

Default position of the rotary selector switches Group and Scene is 0 in this position Scene 0 – 5 will be recalled and all commands will be send via Broadcast to the whole DALI line.

- ① Broadcast go to Scene 0
- ② Broadcast go to Scene 1
- ③ Broadcast go to Scene 2
- ④ Broadcast go to Scene 3
- ⑤ Broadcast go to Scene 4
- ⑥ Broadcast go to Scene 5
- ⑦ Position LED activate/deactivate with long press default activated

If the rotary selector switch Scene is in position 12 then Scenes 12, 13, 14, 15 and 0 will be recalled and if the rotary selector switch Group is in position 14 then the Scene commands will be only recalled for Group 13. No other Group will react to the send commands.

- ① Group 13 go to Scene 12
- ② Group 13 go to Scene 13
- ③ Group 13 go to Scene 14
- ④ Group 13 go to Scene 15
- ⑤ Group 13 go to Scene 0
- ⑥ Group 13 go to Scene 1
- ⑦ Position LED activate/deactivate with long press default activated

3.4 DALI TOUCHPANEL BASIC TW

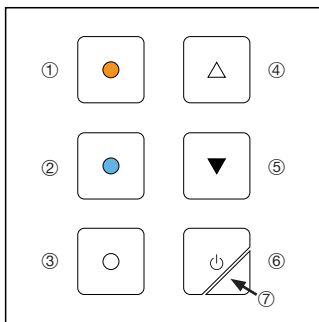

Front view

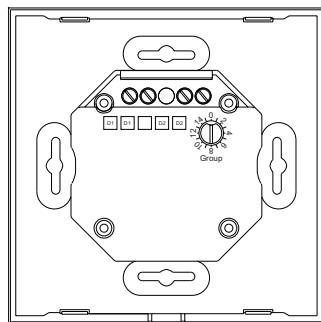

Back view

DALI TOUCHPANEL BASIC Tunable White allows an easy way to control Tunable White luminaries and offers one rotary selector switch on the back. Depending on the position of the Group rotary selector switch different Groups 0 – 14 or the whole DALI line can be controlled.

Default position of the rotary selector switch is 0 in this position commands will be send as Broadcast commands to the whole DALI line.

- ① Short/long press Broadcast step warmer
- ② Short/long press Broadcast step cooler
- ③ Short/long press Broadcast recall colour temperature value 4,000 K
- ④ Short/long press Broadcast dim up
- ⑤ Short/long press Broadcast dim down
- ⑥ Broadcast toggle between recall max / off
- ⑦ Position LED activate/deactivate with long press default activated

If the rotary selector switch is in position 11 then Group 10 will be controlled, no other Group will react to the send commands. Following commands will be send out to the DALI line.

- ① Short/long press Group 10 step warmer
- ② Short/long press Group 10 step cooler
- ③ Short/long press Group 10 recall colour temperature value 4,000 K
- ④ Short/long press Group 10 dim up
- ⑤ Short/long press Group 10 dim down
- ⑥ Group 10 toggle between recall max / off
- ⑦ Position LED activate/deactivate with long press default activated

## 4. Installation / wiring

### 4.1 Wiring diagram

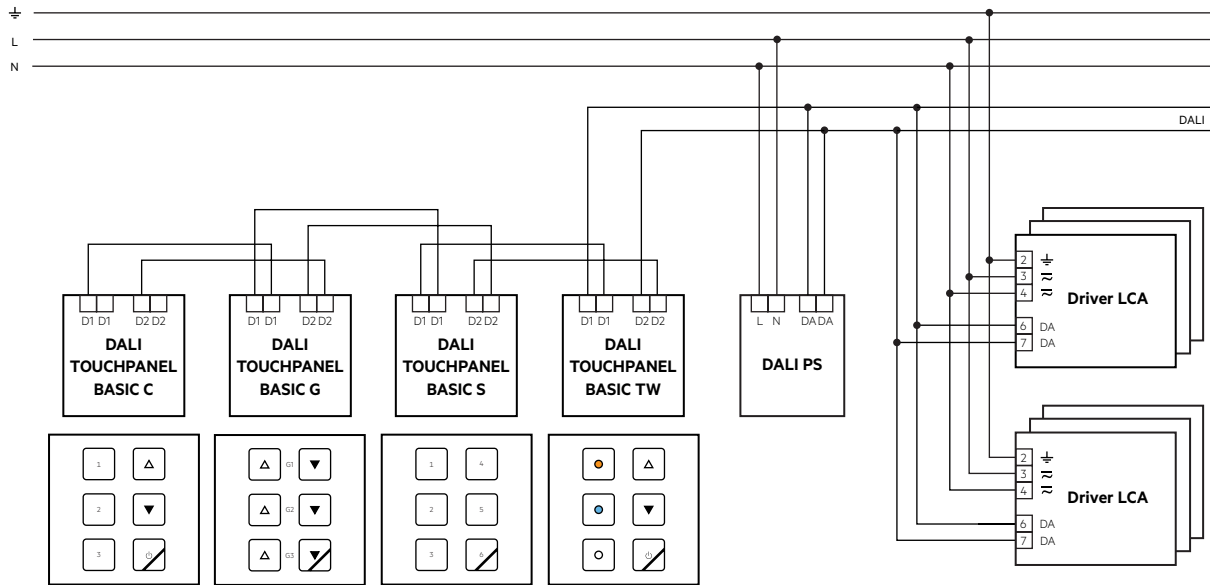

### 4.2 Wiring type and cross section

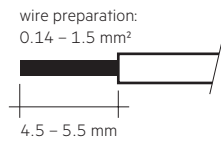

The wiring can be solid wire or stranded wire with a cross-section of 0.14 to 1.5 mm<sup>2</sup>.

### 4.3 Installation and safety instructions:

- **DALI is not SELV.** Apply the installation instructions for mains voltage
- Installation: fixed only, in a clean and dry environment
- Supply: via DALI control line only; no mains voltage allowed
- DALI control line: use standard installation material for low-voltage systems (< 1000 V); only tree, linear and star topologies permitted; cores may be reverse connected
- Terminals D1/D2: do not connect with mains line
- Terminals: when using solid conductors, connect only one per terminal
- The Touchpanels do send Group and Scene commands. Make sure your devices are grouped and Scene values are saved correctly
- Handle with care, the glass may be damaged if dropped, burned, punctured or crushed
- Static electricity, sweat, oil and other impurities on your hand or on the touch panel may result in a not responsive touchscreen. If this happens please make sure to clean the touch panel and your hands.
- The device may only be used for the application area specified
- Relevant health and safety regulations must be observed
- While assembling and installing the device, the voltage supply must be disconnected
- Only qualified personnel may assemble, install and commission the device
- If an error occurs, dangerous voltage levels may be present at the DALI terminals and on the DALI control line

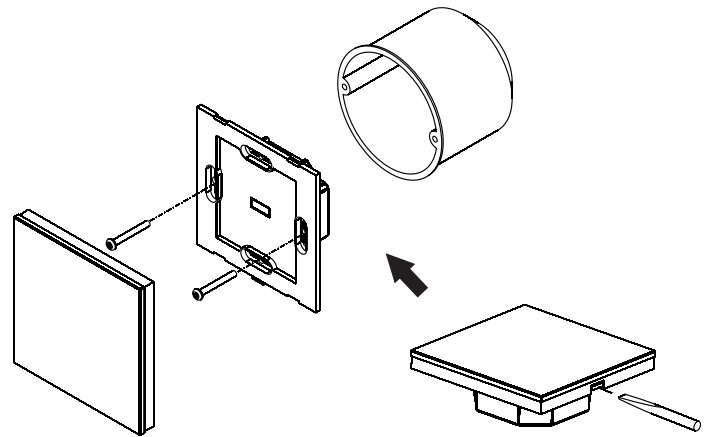

## 5. Miscellaneous

### 5.1 Disposal



According to the WEEE directive return old equipment at appropriate collection facilities.

### 5.2 Additional information

Additional technical information at [www.tridonic.com](http://www.tridonic.com) → Technical Data

Guarantee conditions at [www.tridonic.com](http://www.tridonic.com) → Services

Lifetime declarations are informative and represent no warranty claim.  
No warranty if device was opened.